



JIS B 6339 (MAS 403 BT)

A - AD - AD/B

Werkzeugaufnahmen

Toolholders

Porte-outils

Takım Tutucular

INHALTSVERZEICHNIS / INDEX	Seite / Page
Spannzangenfutter - Collet chuck Mandrin à pincés - Pens başlığı	2.04 - 2.09
Ausrichtbares Spann Futter - Adjustable tool holder Tige de réglage - Hassas ayarlanabilir pens tutucu	2.10
Kraftspannfutter - Power milling chuck Mandrin de fraiseage - Bilyalı pens tutucu	2.11
Fräseraufnahmen - End mill holder Porte-fraises - Veldon tutucu	2.12 - 2.21
Spannzangenfutter - Pull type collet chuck Mandrin de serrage de précision - Çektirmeli pens başlığı	2.22 - 2.24
Morsekegel Aufnahmen - Morse taper adapter Douilles intermédiaires - Mors adaptörü	2.25
Zwischenhülsen mit Anzugsgewinde - Morse taper adapter Douilles intermédiaires - Mors adaptörü çektirmeli	2.26
Reduzierungen - Reduction sleeves Douilles de réduction - Redüksiyon	2.26
Kombi-Aufsteckfräserdorne - Combi shell mill holder Porte-fraises à double usage pour fraises - Kombine malafa	2.27 - 2.30
Quernut-Aufsteckdorne - Shell mill holder Porte-fraises à surfacer - Alın kamalı malafa	2.31 - 2.34
Aufschraubfräser - Milling cutter arbors Axess coupeur fraiseage - Vidalı takım tutucu	2.35 - 2.37
Bohrerhalter E1 - Boring holder E1 Porte foret E1 - Takma uçlu drill tutucu E1	2.38
Bohrfutteraufnahme - Drill chuck Arbre pour mandrin de perçage - Mandren malafası	2.38
NC -Bohrfutter - NC - Drill chuck Mandrin de perçage - NC mandren malafası	2.39
Gewindeschneidfutter - Quick change tapping chuck Appareil à tarauder - Kılavuz çekme başlığı	2.40
Rohlinge - Blanks Barre d'alésage - Özel takım yapma amaçlı yarı mamul	2.41
Kontrolldorne - Test arbors Mandrin de contrôle - Kontrol mastarı	2.41
Schrumpffutter - Shrink chuck Mandrin de fretage - Isıtmalı takım tutucu	2.42 - 2.46
Hydro - Dehnspannfutter - Hydraulic expansion chuck Mandrin expansibles - Hidrolik takım tutucu	2.47 - 2.50



JIS B 6339
(MAS 403 BT)

Mit EROGLU erhalten Sie auch Semi-Standard – in der gleichen Qualität!

With EROGLU you receive semi-standard, too – within the same quality!

Avec EROGLU vous recevez aussi semi-standard – avec la même qualité!

Özel ürün seçenekleri ile EROĞLU kalitesi hep sizinle...

. ERP

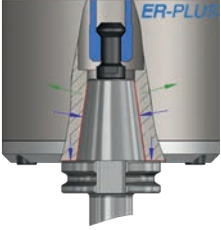

BT Halter können als ER-PLUS (Doppelkontakt) gefertigt werden
(Beispiel Bestellnummer: 405.02.10.63.ERP)

BT products can be produced as ER-PLUS (Dual face contact)
(Example order code no: 405.02.10.63.ERP)

Mandrins BT peut être fabrique comme version ER-PLUS (double contact)
(Exemple commande no: 405.02.10.63.ERP)

Tüm BT ürünler ER-PLUS (Çift yüzey temaslı) olarak üretilebilir.
(Örnek sip. Nr. : 405.02.10.63.ERP)

. ON



Alle BT30 Aufnahmen auf seite 2.05 - 2.12 - 2.27 - 2.42 können für
Holzbearbeitungsmaschinen als Typ "ON" (ohne Mitnehmernuten und ohne
Positionierungskerbe) bestellt werden. (Beispiel Bestellnummer: 305.02.10.70.ON)

All BT30 chucks at page 2.05 - 2.12 - 2.27 - 2.42 can be ordered for wooden
machines as type "ON" (without driving grooves and without positioning mark).
(Example order code no: 305.02.10.70.ON)

Tous les mandrins BT30 à la page 2.05 - 2.12 - 2.27 - 2.42 peuvent également être
commandés pour les machines à bois de type "ON" (sans rainure de clavette et
sans marquage de positionnement). (Exemple commande no: 305.02.10.70.ON)

Sayfa numaraları belirtilen takım tutucular için BT30 kama kanalsız üretilebilir.
Sayfa 2.05 - 2.12 - 2.27 - 2.42 (Örnek sip. Nr. : 305.02.10.70.ON)

. G2.5 x ...

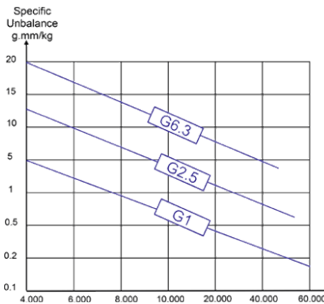

Alle Artikel können mit dem angegeben Maximalwert feingewuchtet werden.

All products can be produced in the specified maximum balance value.

Tous les articles peuvent être spécifiés avec le maximum de précision équilibrée.

Tüm takım tutucular belirlenen max. balans değerlerinde üretilebilir.

Standard Werkzeug-System
Standard Tooling System
système d'outils standard
Standart Takım sistemi
Abstand / Distance / Distance / Mesafe

ER-PLUS Werkzeug-System
ER-PLUS Tooling System
ER-PLUS système d'outils
ER-PLUS Takım Sistemi
Kontakt / Contact / Contact / Temas

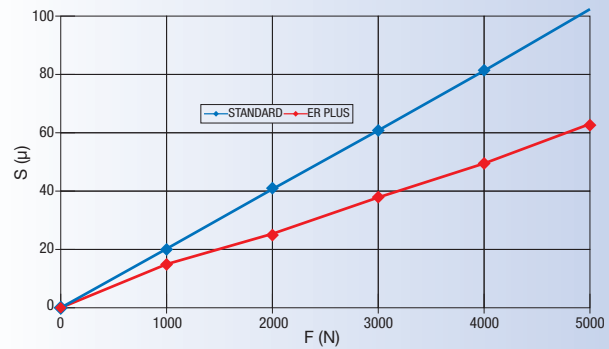
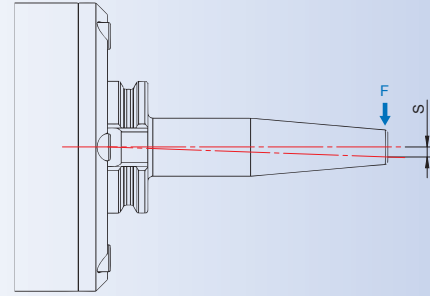
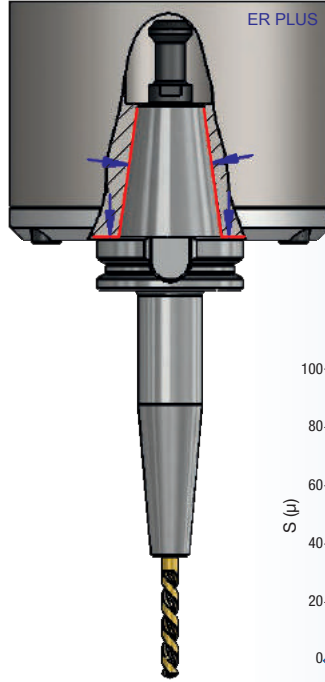
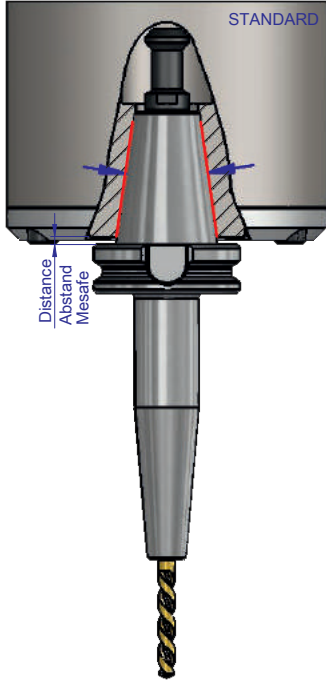

Der Unterschied des ER-PLUS Systems zur konventionellen Schnittstelle, ist eine doppelte Kontaktfläche: am Kegel und gleichzeitig am Werkzeugflansch. Dies erlaubt eine höhere Radialsteifigkeit.

The differences between standard contact face to ER-PLUS system, is a dual contact face: by shank and also flange face. This allows a higher radial rigidity.

La différence du système ER-PLUS d'interface est un contact double: au cône et bride. C'est rendre possible une plus haut rigidité radiale.

Standart takım sistemi ile ER-PLUS takım sistemi arasındaki farklılık, ER-PLUS sisteminde konikte ve alında çift temas yüzeyi sağlamaktır. Bu takımda yüksek radyal rijitlik sağlar.

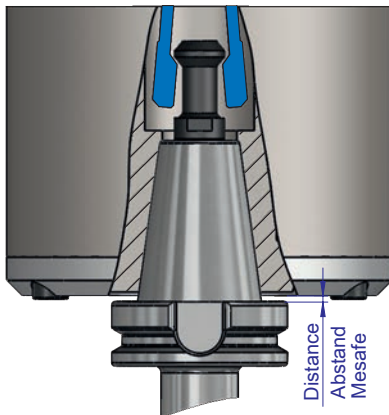

Vor dem Einspannen
Before clamping
Avant tendre
Çektirmeden önce

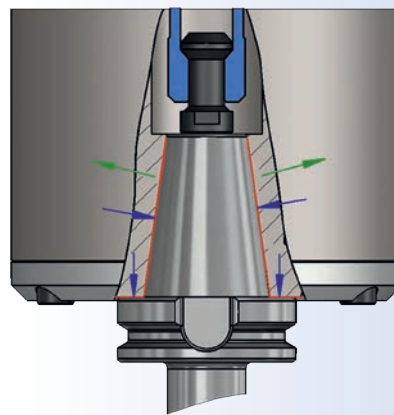

Nach dem Einspannen
After clamping
Après tendre
Çektirmeden sonra

Beispiel Bestellnummer : 406.25.06.90.ERP
Example order code no : 406.25.06.90.ERP
Exemple commande no : 406.25.06.90.ERP
Örnek sipariş numarası : 406.25.06.90.ERP



Werkzeugaufnahmen

JIS B 6339 (MAS 403 BT) AD

Toolholders

Porte-outils

Merkezden Soğutmalı
Konik Şaft Ölçüleri

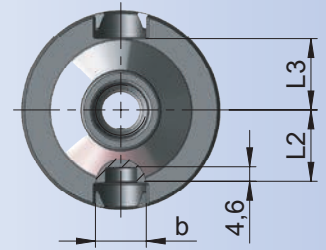
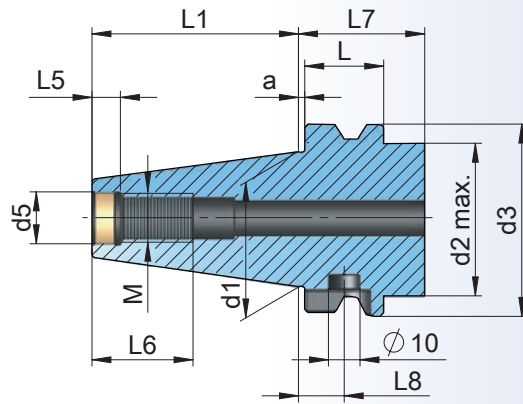

Werkzeugaufnahmen

JIS B 6339 (MAS 403 BT) AD/B

Toolholders

Porte-outils

Merkezden ve
(B) Alından Soğutmalı
Konik Şaft Ölçüleri

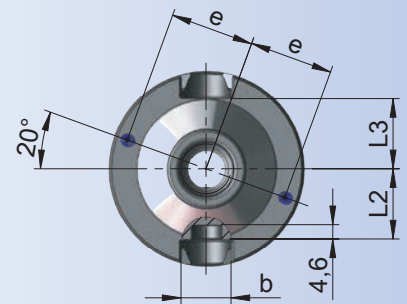
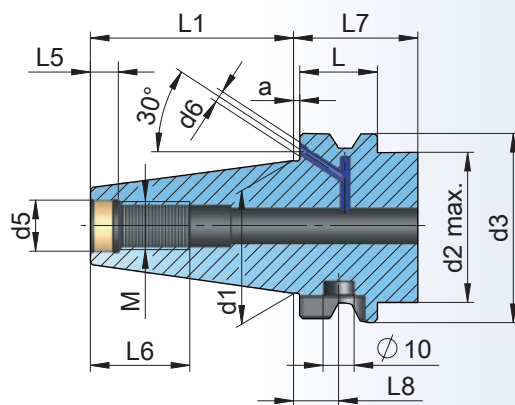

Werkzeugaufnahmen BT ERPLUS

JIS B 6339 (MAS 403 BT) AD

Toolholders BT ERPLUS

Porte-outils BT ERPLUS

Merkezden Soğutmalı
Konik Şaft Ölçüleri

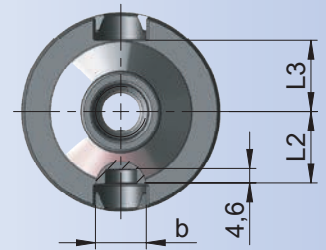
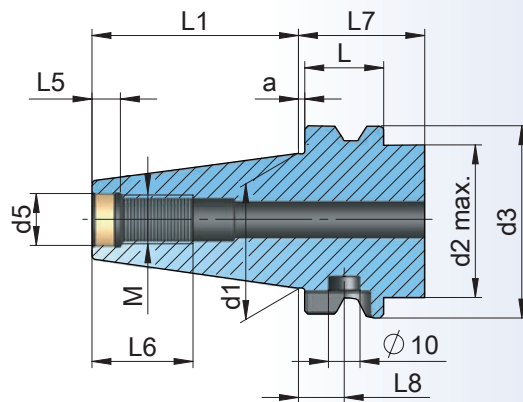

Werkzeugaufnahmen BT ERPLUS

JIS B 6339 (MAS 403 BT) AD/B

Toolholders BT ERPLUS

Porte-outils BT ERPLUS

Merkezden ve
(B) Alından Soğutmalı
Konik Şaft Ölçüleri

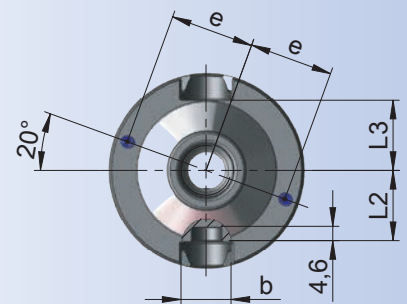
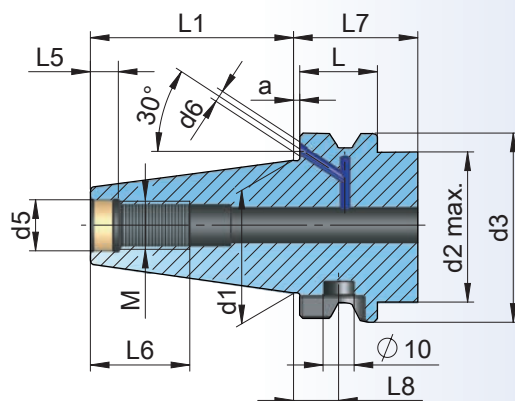



BT	FORM	d1	a	M	L6	d3	L	d2 max.	L7	L1	d5	L5	b	L2	L3	L8	d6	e
BT 30	AD	31,75	2,0	M12	27	46	20	45	30	48,4	12,5	7	16,1	16,3	16,3	11,0	-	-
BT 40	AD	44,45	2,0	M16	32	63	25	61	37	65,4	17,0	9	16,1	22,6	22,6	14,5	-	-
BT 40	AD/B	44,45	2,0	M16	32	63	25	61	37	65,4	17,0	9	16,1	22,6	22,6	14,5	4	27
BT 40-ERP	AD	44,45	1,0	M16	32	63	26	61	37	65,4	17,0	9	16,1	22,6	22,6	14,5	-	-
BT 40-ERP	AD/B	44,45	1,0	M16	32	63	26	61	37	65,4	17,0	9	16,1	22,6	22,6	14,5	4	27
BT 50	AD	69,85	3,0	M24	47	100	35	98	50	101,8	25,0	13	25,7	35,4	35,4	20,5	-	-
BT 50	AD/B	69,85	3,0	M24	47	100	35	98	50	101,8	25,0	13	25,7	35,4	35,4	20,5	6	42
BT 50-ERP	AD	69,85	1,5	M24	47	100	36,5	98	50	101,8	25,0	13	25,7	35,4	35,4	20,5	-	-
BT 50-ERP	AD/B	69,85	1,5	M24	47	100	36,5	98	50	101,8	25,0	13	25,7	35,4	35,4	20,5	6	42

Werkstoff : Legierter Einsatzstahl mit einer Zugfestigkeit im Kern von min. 950 N/mm²

Ausführung : Einsatzgehärtet HRC 58 ± 2 Härtetiefe 0,6 mm + 0,2 mm, brüniert

Genauigkeit : Kegelwinkel-Toleranzqualität AT 3 nach DIN 2080
Oberflächenrauigkeit des Kegels Ra 0,2

Chip : Bohrung für Datenträger DIN 69873 im Bund.

Material : Case hardened steel, tensile strength in the core min. 950 N/mm²

Execution : Case hardened HRC 58 ± 2 Depth of case 0,6 mm + 0,2 mm,
black-finish

Accuracy : Cone angle AT 3 according DIN 2080
Surface roughness of cone Ra 0,2

Chip hole : Bore for data carrier DIN 69873 in collar.

Matière : Châssis d'allié en acier de cémentation. Résistance à la traction dans le noyau
de min 950 N/mm²

Exécution : Cémenté HRC 58 ± 2 Epaisseur de cémentation 0,6 mm + 0,2 mm
Bruni

Précision : Qualité de finition pour l'angle des cônes AT 3 suivant DIN 2080
Rugosité en surface du cône Ra 0,2

Puce : Pergage pour support de données DIN 69873 dans la collerette.

Malzeme : Alaşımlı sement çeliği çekme mukavemeti min. 950 N/mm²

Teknik özelliği : Sertlik HRC 58 ± 2 sertlik derinliği 0,6 mm + 0,2 mm, karartılmış

Hassasiyeti : Konik açı tolerans kalitesi DIN 2080 normuna göre AT 3
Konik yüzey kalitesi Ra 0,2

Çip deliği : Takım bilgilerini saklamak için flanşta DIN 69873 özel çip deliği.



Spannfutter OZ

Collet chucks OZ

Mandrin à pinces OZ

Pens başlığı OZ

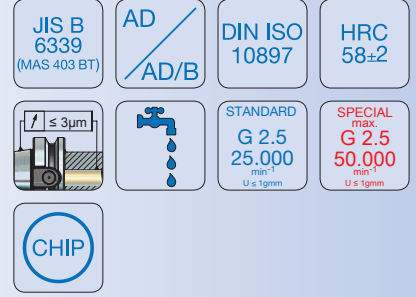

Bestell-Nr. Order Nr. Reference Sipariş Nr.	BT	Form	Abmessung Size Dimension Cinsi	Spannbereich Capacity Capacité Kapasite	A	D	L2	Kg	Euro
•305.01.16.60	BT 30	AD	OZ 16	415 E (2-16)	60	43	51	0,57	
•305.01.25.80	BT 30	AD	OZ 25	462 E (2-25)	80	60	64	0,95	
405.01.16.70	BT 40	AD	OZ 16	415 E (2-16)	70	43	51	1,20	
406.01.16.70	BT 40	AD/B	OZ 16	415 E (2-16)	70	43	51	1,19	
405.01.16.100	BT 40	AD	OZ 16	415 E (2-16)	100	43	51	1,51	
406.01.16.100	BT 40	AD/B	OZ 16	415 E (2-16)	100	43	51	1,51	
405.01.25.70	BT 40	AD	OZ 25	462 E (2-25)	70	60	64	1,37	
406.01.25.70	BT 40	AD/B	OZ 25	462 E (2-25)	70	60	64	1,37	
405.01.25.100	BT 40	AD	OZ 25	462 E (2-25)	100	60	64	2,01	
406.01.25.100	BT 40	AD/B	OZ 25	462 E (2-25)	100	60	64	2,00	
•405.01.32.90	BT 40	AD	OZ 32	467 E (4-32)	90	72	74	1,87	
•406.01.32.90	BT 40	AD/B	OZ 32	467 E (4-32)	90	72	74	1,86	
505.01.16.70	BT 50	AD	OZ 16	415 E (2-16)	70	43	51	3,74	
506.01.16.70	BT 50	AD/B	OZ 16	415 E (2-16)	70	43	51	3,72	
505.01.25.85	BT 50	AD	OZ 25	462 E (2-25)	85	60	64	4,11	
506.01.25.85	BT 50	AD/B	OZ 25	462 E (2-25)	85	60	64	4,10	
505.01.32.90	BT 50	AD	OZ 32	467 E (4-32)	90	72	74	4,36	
506.01.32.90	BT 50	AD/B	OZ 32	467 E (4-32)	90	72	74	4,35	
505.01.32.110	BT 50	AD	OZ 32	467 E (4-32)	110	72	74	4,98	
506.01.32.110	BT 50	AD/B	OZ 32	467 E (4-32)	110	72	74	4,96	

FORM AD

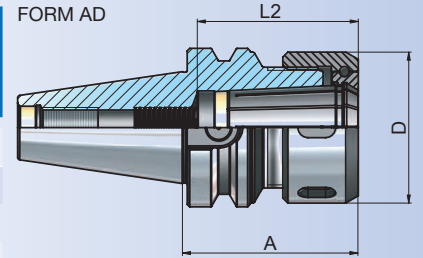

FORM AD/B

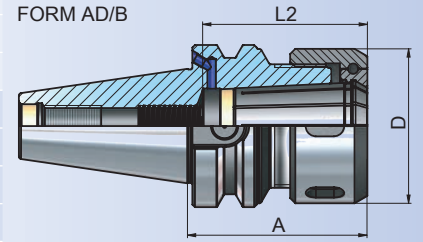

- Technisch gibt es keinen Chip.
- Technically there is no chip hole.
- Techniquement, il n'y a pas de puce.
- Teknik açıdan çip deliği bulunmamaktadır.

Zubehör / Accessories / Accessoires / Yedekler



Spannzangen OZ
Collets OZ
Pincés de serrage OZ
Pens OZ



Spannmutter OZ
Clamping nuts OZ
Écrou de serrage OZ
Pens kapağı OZ



Hakenschlüssel
Wrench
Clé à ergot
E tipi ay anahtar



Spannfutter ER

Collet chucks ER

Mandrin à pinces ER

Pens başlığı ER

JIS B
6339
(MAS 403 BT)

AD
AD/B

DIN ISO
15488

HRC
58±2



STANDARD
G 2.5
min⁻¹
U ≤ 1gmm

SPECIAL
max.
G 2.5
50.000
min⁻¹
U ≤ 1gmm



JIS B 6339
(MAS 403 BT)

Bestell-Nr. Order Nr. Reference Sipariş Nr.	BT	Form	Spannbereich Capacity Capacité Kapasite	A	D	D1	L1	L2	Kg	Euro
305.02.10.70	BT 30	AD	ER16 (1 - 10)	70	28	-	-	32	0,54	
305.02.10.100	BT 30	AD	ER16 (1 - 10)	100	28	-	-	32	0,67	
305.02.16.70	BT 30	AD	ER25 (2 - 16)	70	42	-	-	42	0,66	
305.02.16.100	BT 30	AD	ER25 (2 - 16)	100	42	-	-	42	0,97	
305.02.20.70	BT 30	AD	ER32 (2 - 20)	70	50	-	-	48	0,66	
305.02.20.100	BT 30	AD	ER32 (2 - 20)	100	50	-	-	48	0,94	
•305.02.26.70	BT 30	AD	ER40 (3 - 26)	70	63	-	-	55	0,81	

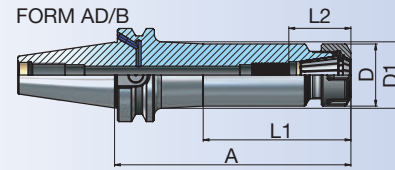
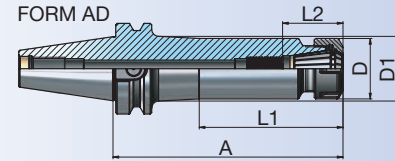

405.02.10.63	BT 40	AD	ER16 (1 - 10)	63	28	-	-	32	1,06	
406.02.10.63	BT 40	AD/B	ER16 (1 - 10)	63	28	-	-	32	1,06	
405.02.10.100	BT 40	AD	ER16 (1 - 10)	100	28	-	-	32	1,21	
406.02.10.100	BT 40	AD/B	ER16 (1 - 10)	100	28	-	-	32	1,20	
405.02.10.130	BT 40	AD	ER16 (1 - 10)	130	28	-	-	32	1,33	
406.02.10.130	BT 40	AD/B	ER16 (1 - 10)	130	28	-	-	32	1,32	
405.02.10.160	BT 40	AD	ER16 (1 - 10)	160	28	31,5	98	32	1,47	
406.02.10.160	BT 40	AD/B	ER16 (1 - 10)	160	28	31,5	98	32	1,46	
406.02.10.200	BT 40	AD/B	ER16 (1 - 10)	200	28	33	120	32	1,66	
new 406.02.13.70	BT 40	AD/B	ER20 (1 - 13)	70	34	-	-	39,5	1,13	
new 406.02.13.100	BT 40	AD/B	ER20 (1 - 13)	100	34	-	-	39,5	1,32	
new 406.02.13.130	BT 40	AD/B	ER20 (1 - 13)	130	34	-	-	39,5	1,50	
new 406.02.13.160	BT 40	AD/B	ER20 (1 - 13)	160	34	37,5	99,5	39,5	1,72	
405.02.16.60	BT 40	AD	ER25 (2 - 16)	60	42	-	-	42	1,09	
406.02.16.60	BT 40	AD/B	ER25 (2 - 16)	60	42	-	-	42	1,09	
405.02.16.100	BT 40	AD	ER25 (2 - 16)	100	42	-	-	42	1,49	
406.02.16.100	BT 40	AD/B	ER25 (2 - 16)	100	42	-	-	42	1,49	
405.02.16.130	BT 40	AD	ER25 (2 - 16)	130	42	-	-	42	1,80	
406.02.16.130	BT 40	AD/B	ER25 (2 - 16)	130	42	-	-	42	1,79	
405.02.16.160	BT 40	AD	ER25 (2 - 16)	160	42	45	100	42	2,12	
406.02.16.160	BT 40	AD/B	ER25 (2 - 16)	160	42	45	100	42	2,12	
406.02.16.200	BT 40	AD/B	ER25 (2 - 16)	200	42	47	122	42	2,56	



ER 16

- Technisch gibt es keinen Chip.
- Technically there is no chip hole.
- Techniquement, il n'y a pas de puce.
- Teknik açıdan çip deliği bulunmamaktadır.

Zubehör / Accessories / Accessoires / Yedekler



Spannzangen System ER
Collets System ER
Pinces de serrage System ER
Pens ER



Spannmutter ER
Clamping nuts ER
Écrou de serrage ER
Pens kapağı ER



Spannchlüssel für ER
Wrench ER
Clé de serrage ER
Anahtar ER



11.01



Spannfutter ER

Collet chucks ER

Mandrin à pinces ER

Pens başlığı ER

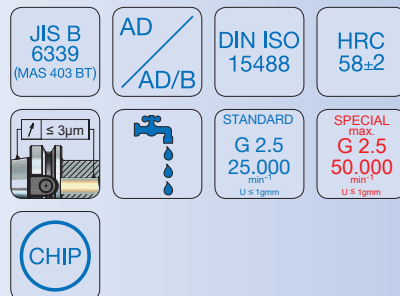

Bestell-Nr. Order Nr. Reference Sipariş Nr.	BT	Form	Spannbereich Capacity Capacité Kapasite	A	D	D1	L1	L2	Kg	Euro
405.02.20.70	BT 40	AD	ER32 (2 - 20)	70	50	-	-	48	1,25	
406.02.20.70	BT 40	AD/B	ER32 (2 - 20)	70	50	-	-	48	1,24	
405.02.20.100	BT 40	AD	ER32 (2 - 20)	100	50	-	-	48	1,68	
406.02.20.100	BT 40	AD/B	ER32 (2 - 20)	100	50	-	-	48	1,68	
405.02.20.130	BT 40	AD	ER32 (2 - 20)	130	50	-	-	48	2,12	
406.02.20.130	BT 40	AD/B	ER32 (2 - 20)	130	50	-	-	48	2,12	
405.02.20.160	BT 40	AD	ER32 (2 - 20)	160	50	53,5	101	48	2,58	
406.02.20.160	BT 40	AD/B	ER32 (2 - 20)	160	50	53,5	101	48	2,58	
406.02.20.200	BT 40	AD/B	ER32 (2 - 20)	200	50	55	123	48	3,21	
405.02.26.80	BT 40	AD	ER40 (3 - 26)	80	63	-	-	55	1,61	
406.02.26.80	BT 40	AD/B	ER40 (3 - 26)	80	63	-	-	55	1,61	
405.02.26.100	BT 40	AD	ER40 (3 - 26)	100	63	-	-	55	2,08	
406.02.26.100	BT 40	AD/B	ER40 (3 - 26)	100	63	-	-	55	2,07	
405.02.26.130	BT 40	AD	ER40 (3 - 26)	130	63	-	-	55	2,78	
406.02.26.130	BT 40	AD/B	ER40 (3 - 26)	130	63	-	-	55	2,78	
405.02.26.160	BT 40	AD	ER40 (3 - 26)	160	63	-	-	55	3,48	
406.02.26.160	BT 40	AD/B	ER40 (3 - 26)	160	63	-	-	55	3,48	
406.02.26.200	BT 40	AD/B	ER40 (3 - 26)	200	63	-	-	55	4,42	
505.02.10.70	BT 50	AD	ER16 (1 - 10)	70	28	-	-	32	3,69	
506.02.10.70	BT 50	AD/B	ER16 (1 - 10)	70	28	-	-	32	3,68	
505.02.10.100	BT 50	AD	ER16 (1 - 10)	100	28	-	-	32	3,81	
506.02.10.100	BT 50	AD/B	ER16 (1 - 10)	100	28	-	-	32	3,80	
505.02.10.130	BT 50	AD	ER16 (1 - 10)	130	28	-	-	32	3,93	
506.02.10.130	BT 50	AD/B	ER16 (1 - 10)	130	28	-	-	32	3,91	
505.02.10.160	BT 50	AD	ER16 (1 - 10)	160	28	33	71	32	4,10	
506.02.10.160	BT 50	AD/B	ER16 (1 - 10)	160	28	33	71	32	4,08	
506.02.10.200	BT 50	AD/B	ER16 (1 - 10)	200	28	34	98	32	4,28	

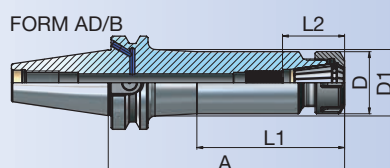
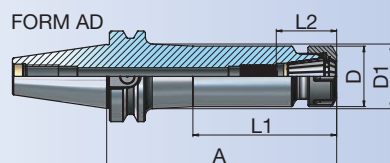

Zubehör / Accessories / Accessoires / Yedekler



Spannzangen System ER
Collets System ER
Pinces de serrage System ER
Pens ER



Spannmutter ER
Clamping nuts ER
Écrou de serrage ER
Pens kapağı ER



Spannschlüssel für ER
Wrench ER
Clé de serrage ER
Anahtar ER



Spannfutter ER

Collet chucks ER

Mandrin à pinces ER

Pens başlığı ER



JIS B
6339
(MAS 403 BT)

AD
AD/B

DIN ISO
15488

HRC
58±2



STANDARD
G 2.5
25.000
min⁻¹
U ≤ 1gmm

SPECIAL
max.
G 2.5
50.000
min⁻¹
U ≤ 1gmm



JIS B 6339
(MAS 403 BT)

Bestell-Nr. Order Nr. Reference Sipariş Nr.	BT	Form	Spannbereich Capacity Capacité Kapasite	A	D	D1	L1	L2	Kg	Euro
new 506.02.13.70	BT 50	AD/B	ER20 (1 - 13)	70	34	-	-	39,5	3,73	
new 506.02.13.100	BT 50	AD/B	ER20 (1 - 13)	100	34	-	-	39,5	3,90	
new 506.02.13.130	BT 50	AD/B	ER20 (1 - 13)	130	34	-	-	39,5	4,09	
new 506.02.13.160	BT 50	AD/B	ER20 (1 - 13)	160	34	39	99,5	39,5	4,29	
505.02.16.70	BT 50	AD	ER25 (2 - 16)	70	42	-	-	42	3,73	
506.02.16.70	BT 50	AD/B	ER25 (2 - 16)	70	42	-	-	50	3,71	
505.02.16.100	BT 50	AD	ER25 (2 - 16)	100	42	-	-	42	4,03	
506.02.16.100	BT 50	AD/B	ER25 (2 - 16)	100	42	-	-	42	4,02	
505.02.16.130	BT 50	AD	ER25 (2 - 16)	130	42	-	-	42	4,33	
506.02.16.130	BT 50	AD/B	ER25 (2 - 16)	130	42	-	-	42	4,32	
505.02.16.160	BT 50	AD	ER25 (2 - 16)	160	42	47	73	42	4,70	
506.02.16.160	BT 50	AD/B	ER25 (2 - 16)	160	42	47	73	42	4,68	
506.02.16.200	BT 50	AD/B	ER25 (2 - 16)	200	42	48	100	42	5,14	
505.02.20.70	BT 50	AD	ER32 (2 - 20)	70	50	-	-	48	3,75	
506.02.20.70	BT 50	AD/B	ER32 (2 - 20)	70	50	-	-	48	3,73	
505.02.20.100	BT 50	AD	ER32 (2 - 20)	100	50	-	-	48	4,17	
506.02.20.100	BT 50	AD/B	ER32 (2 - 20)	100	50	-	-	48	4,16	
505.02.20.130	BT 50	AD	ER32 (2 - 20)	130	50	-	-	48	4,61	
506.02.20.130	BT 50	AD/B	ER32 (2 - 20)	130	50	-	-	48	4,59	
505.02.20.160	BT 50	AD	ER32 (2 - 20)	160	50	55	74	48	5,12	
506.02.20.160	BT 50	AD/B	ER32 (2 - 20)	160	50	55	74	48	5,10	
506.02.20.200	BT 50	AD/B	ER32 (2 - 20)	200	50	55,5	101	48	5,75	
505.02.26.80	BT 50	AD	ER40 (3 - 26)	80	63	-	-	55	4,02	
506.02.26.80	BT 50	AD/B	ER40 (3 - 26)	80	63	-	-	55	4,00	
505.02.26.100	BT 50	AD	ER40 (3 - 26)	100	63	-	-	55	4,49	
506.02.26.100	BT 50	AD/B	ER40 (3 - 26)	100	63	-	-	55	4,47	
505.02.26.130	BT 50	AD	ER40 (3 - 26)	130	63	-	-	55	5,19	
506.02.26.130	BT 50	AD/B	ER40 (3 - 26)	130	63	-	-	55	5,17	
505.02.26.160	BT 50	AD	ER40 (3 - 26)	160	63	67,5	76	55	5,99	
506.02.26.160	BT 50	AD/B	ER40 (3 - 26)	160	63	67,5	76	55	5,97	
506.02.26.200	BT 50	AD/B	ER40 (3 - 26)	200	63	68,5	103	55	6,99	

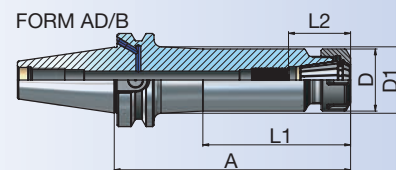
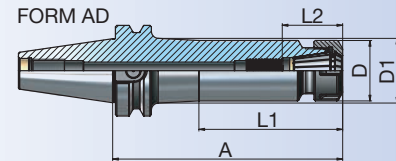

Zubehör / Accessories / Accessoires / Yedekler

DIN ISO
15488



10.11 - 10.18

Spannzangen System ER
Collets System ER
Pincés de serrage System ER
Pens ER

DIN ISO
15488



10.25 - 10.26

Spannmutter ER
Clamping nuts ER
Écrou de serrage ER
Pens kapağı ER



10.48

Spannschlüssel für ER
Wrench ER
Clé de serrage ER



11.01



Spannfutter ER Mini

Collet chucks ER Mini

Mandrin à pincés ER Mini

Pens başlığı ER Mini

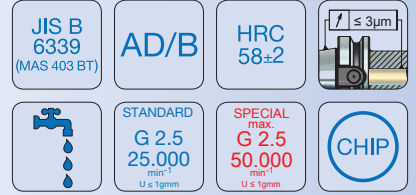

Bestell-Nr. Order Nr. Reference Sipariş Nr.	BT	Form	Spannbereich Capacity Capacité Kapasite	A	D	D1	L1	L2	Kg	Euro
406.02.07.63.M	BT 40	AD/B	ER11 (1 - 7)	63	16	-	-	41,5	1,00	
406.02.07.100.M	BT 40	AD/B	ER11 (1 - 7)	100	16	-	-	41,5	1,06	
406.02.07.130.M	BT 40	AD/B	ER11 (1 - 7)	130	16	-	-	41,5	1,10	
406.02.07.160.M	BT 40	AD/B	ER11 (1 - 7)	160	16	19,5	94,5	41,5	1,15	
406.02.10.100.M	BT 40	AD/B	ER16 (1 - 10)	100	22	-	-	32	1,11	
406.02.10.130.M	BT 40	AD/B	ER16 (1 - 10)	130	22	-	-	32	1,19	
406.02.10.160.M	BT 40	AD/B	ER16 (1 - 10)	160	22	25,5	98	32	1,29	
506.02.10.100.M	BT 50	AD/B	ER16 (1 - 10)	100	22	-	-	32	3,73	
506.02.10.130.M	BT 50	AD/B	ER16 (1 - 10)	130	22	-	-	32	3,81	
506.02.10.160.M	BT 50	AD/B	ER16 (1 - 10)	160	22	27	71	32	3,93	

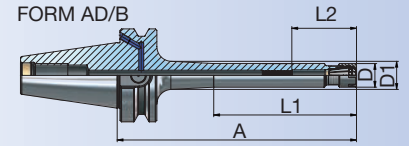

Zubehör / Accessories / Accessoires / Yedekler



Spannzangen System ER
Collets System ER
Pincés de serrage System ER
Pens ER



Spannmutter Mini
Nut Mini
Écrou mini
Mini kapak



Rollenschlüssel für Spannmutter
Roller Bearing Wrenches
Cles à rouleaux
Bilyalı Kapak Sıkma Anahtarı



Spannschlüssel
Wrench
Clé de serrage
Anahtar ER



i

11.01



Spannfuttersatz im Koffer

Collet chuck set in box

Mandrin á pincas pour pincas (set) dans coffre

Pens başlığı seti plastik kutuda

JIS B
6339
(MAS 403 BT)

AD/B

DIN ISO
10897

HRC
58±2



Bestell-Nr. Order Nr. Reference Sipariş Nr.	BT	Form	Abmessung Size Dimension Cinsi	Spannbereich Capacity Capacité Kapasite	Spannzangen Durchmesser Collet Diameter Pincas Diamètre Pens Çapı	Spannzangen Stk.		
						Collet Pcs. Pincas Pens Adedi	Kg	Euro
new 406.61.16.70	BT 40	AD/B	OZ 16	415 E (2 - 16)	4-5-6-7-8-9-10-11-12-14-15-16	12	2,81	
new 406.61.25.70	BT 40	AD/B	OZ 25	462 E (2 - 25)	4-5-6-7-8-9-10-11-12-14-16-18-20-22-24-25	16	5,64	
new 406.61.32.90	BT 40	AD/B	OZ 32	467 E (4 - 32)	6-7-8-9-10-12-14-16-18-20-22-24-25-28-30-32	16	9,03	
new 506.61.25.85	BT 50	AD/B	OZ 25	462 E (2 - 25)	4-5-6-7-8-9-10-11-12-14-16-18-20-22-24-25	16	8,63	
new 506.61.32.90	BT 50	AD/B	OZ 32	467 E (4 - 32)	6-7-8-9-10-12-14-16-18-20-22-24-25-28-30-32	16	11,52	

Lieferumfang : Spannfutter, inkl. Spannzangen mit Schlüssel

Included : Collet chuck with collets and wrench

Inclus : Mandrin avec pincas et clé

Teslim Şekli : Tutucu, pensleri ve anahtarlarıyla birlikte

• Technisch gibt es keinen Chip.

• Technically there is no chip hole.

• Techniquement, il n'y a pas de puce.

• Teknik açıdan çip deliği bulunmamaktadır.

Zubehör / Accessories / Accessoires / Yedekler



DIN ISO
10897
Spannzangen OZ
Collets OZ
Pincas de serrage OZ
Pens OZ



DIN ISO
10897
Spannmutter OZ
Clamping nuts OZ
Écrou de serrage OZ
Pens kapağı OZ



DIN 1810 A
Hakenschlüssel
Wrench
Clé à ergot
E tipi ay anahtar



Spannfuttersatz im Koffer

Collet chuck set in box

Mandrin á pincas pour pincas (set) dans coffre

Pens başlığı seti plastik kutuda

JIS B
6339
(MAS 403 BT)

AD/B

DIN ISO
15488

HRC
58±2



Bestell-Nr. Order Nr. Reference Sipariş Nr.	SK	Form	Spannbereich Capacity Capacité Kapasite	Spannzangen Durchmesser Collet Diameter Pincas Diamètre Pens Çapı	Spannzangen Stk.		
					Collet Pcs. Pincas Pens Adedi	Kg	Euro
new 406.62.16.60	BT 40	AD/B	ER25 (2 - 16)	3-4-5-6-7-8-9-10-11-12-14-16	15	2,61	
new 406.62.20.70	BT 40	AD/B	ER32 (2 - 20)	4-5-6-7-8-9-10-11-12-13-14-15-16-18-20	16	4,50	
new 406.62.26.80	BT 40	AD/B	ER40 (3 - 26)	4-5-6-7-8-9-10-12-14-16-18-20-22-24-25-26	16	6,91	
new 506.62.20.70	BT 50	AD/B	ER32 (2 - 20)	4-5-6-7-8-9-10-11-12-13-14-15-16-18-20	15	8,09	
new 506.62.26.80	BT 50	AD/B	ER40 (3 - 26)	4-5-6-7-8-9-10-12-14-16-18-20-22-24-25-26	16	9,56	

Lieferumfang : Spannfutter, inkl. Spannzangen mit Schlüssel

Included : Collet chuck with collets and wrench

Inclus : Mandrin avec pincas et clé

Teslim Şekli : Tutucu, pensleri ve anahtarlarıyla birlikte

Zubehör / Accessories / Accessoires / Yedekler



DIN ISO
15488
Spannzangen System ER
Collets System ER
Pincas de serrage System ER
Pens ER



DIN ISO
15488
Spannmutter ER
Clamping nuts ER
Écrou de serrage ER
Pens kapağı ER



DIN 1048
Spannschlüssel für ER
Wrench ER
Clé de serrage ER
Anahtar ER





Ausrichtbares Werkzeugspannfutter, radial und axial einstellbar

Adjustable toolholder, adjustable radial and axial

Mandrin à tige de réglage, réglage radial et axial

Hassas ayarlanabilir pens tutucular, eksenel ve radyal yönde

JIS B
6339
(MAS 403 BT)

AD/B

DIN ISO
15488

HRC
58±2



Micro-mec ARF-Plus Ausrichtfutter

Bestell-Nr. Order Nr. Reference Sipariş Nr.	BT	Form	Spannbereich Capacity Capacité Kapasite	D	A	L1	L2	D1	M	M1	Kg	Euro
406.02.20.114.ARF-P	BT 40	AD/B	ER32 (2 - 20)	50	114	47	48	68	M6	M6	2,12	
506.02.20.124.ARF-P	BT 50	AD/B	ER32 (2 - 20)	50	124	47	48	68	M6	M6	4,94	

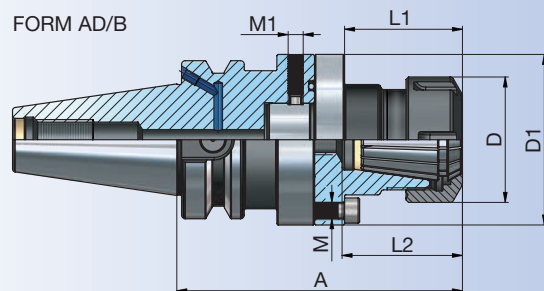

Zubehör / Accessories / Accessoires / Yedekler



DIN ISO
15488
Spannzangen System ER
Collets System ER
Pinces de serrage System ER
Pens ER



DIN ISO
15488
Spannmutter ER
Clamping nuts ER
Écrou de serrage ER
Pens kapağı ER



DIN 912
Anzugschraube
Bolt
Trette
Civata



DIN 915
Einstellschraube
Adjusting screw
Vis de réglage
Ayar civatası



Spannschlüssel für ER
Wrench ER
Clé de serrage ER
Anahtar ER



11.04



Präzisionskraftspannfutter

Precision milling chuck

Mandrin de fraisage de précision

Bilyalı pens tutucu

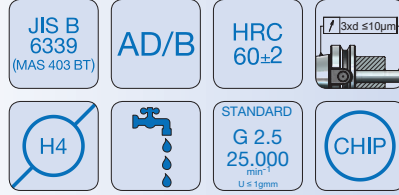

Bestell-Nr. Order Nr. Reference Sipariş Nr.	BT	Form	Spannbereich Capacity Capacité Kapasite	d	A	D	L2	Kg	Euro
new 406.03.20.75.N	BT 40	AD/B	EKS 20 (6 - 20)	20	75	48	80	1,42	
new 406.03.20.130.N	BT 40	AD/B	EKS 20 (6 - 20)	20	130	48	80	2,13	
new 406.03.20.160.N	BT 40	AD/B	EKS 20 (6 - 20)	20	160	48	80	2,53	
new 406.03.20.200.N	BT 40	AD/B	EKS 20 (6 - 20)	20	200	48	80	3,04	
new 406.03.25.90.N	BT 40	AD/B	EKS 25 (6 - 25)	25	90	55	80	2,40	
new •406.03.32.90.N	BT 40	AD/B	EKS 32 (6 - 32)	32	90	68	80	2,01	
new 406.03.32.130.N	BT 40	AD/B	EKS 32 (6 - 32)	32	130	68	80	3,10	
new 406.03.32.160.N	BT 40	AD/B	EKS 32 (6 - 32)	32	160	68	80	3,93	
new 406.03.32.200.N	BT 40	AD/B	EKS 32 (6 - 32)	32	200	68	80	4,63	
new 506.03.20.90.N	BT 50	AD/B	EKS 20 (6 - 20)	20	90	48	80	4,24	
new 506.03.20.130.N	BT 50	AD/B	EKS 20 (6 - 20)	20	130	48	135	4,52	
new 506.03.20.160.N	BT 50	AD/B	EKS 20 (6 - 20)	20	160	48	100	5,38	
new 506.03.20.200.N	BT 50	AD/B	EKS 20 (6 - 20)	20	200	48	100	5,77	
new 506.03.32.95.N	BT 50	AD/B	EKS 32 (6 - 32)	32	95	68	80	4,51	
new 506.03.32.130.N	BT 50	AD/B	EKS 32 (6 - 32)	32	130	68	80	5,37	
new 506.03.32.160.N	BT 50	AD/B	EKS 32 (6 - 32)	32	160	68	80	6,00	
new 506.03.32.200.N	BT 50	AD/B	EKS 32 (6 - 32)	32	200	68	80	7,20	

FORM AD/B

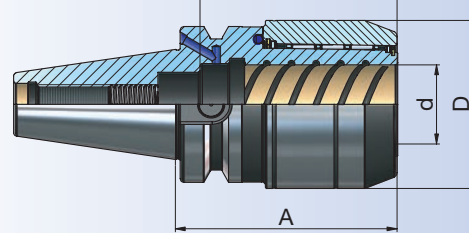

- Technisch gibt es keinen Chip.
- Technically there is no chip hole.
- Techniquement, il n'y a pas de puce.
- Teknik açıdan çip deliği bulunmamaktadır.

Zubehör / Accessories / Accessoires / Yedekler

	Spannzangen Collets Pincés de serrage Pens		Rollenschlüssel für Spannmutter Roller Bearing Wrenches Cles à rouleaux Bilyalı Kapak Sıkma Anahtarı	
10.19		10.47		11.02

Präzisionskraftspannfuttersatz im Koffer

Precision milling chuck set in box

Mandrin de fraisage de précision dans le box

Bilyalı pens tutucu seti plastik kutuda

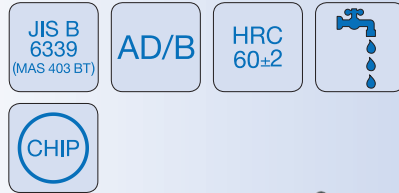

Bestell-Nr. Order Nr. Reference Sipariş Nr.	BT	Form	Spannbereich Capacity Capacité Kapasite	Spannzangen Durchmesser Collet Diameter Pincés Diamètre Pens Çapı	Spannzangen Stk. Collet Pcs. Pincés Pens Adedi	Kg	Euro
new 406.63.20.75.N	BT 40	AD/B	EKS 20 (6 - 20)	6-8-10-12-16	5	3,15	
new •406.63.32.90.N	BT 40	AD/B	EKS 32 (6 - 32)	6-8-10-12-16-20-25	7	5,55	
new 506.63.20.90.N	BT 50	AD/B	EKS 20 (6 - 20)	6-8-10-12-16	5	7,61	
new 506.63.32.95.N	BT 50	AD/B	EKS 32 (6 - 32)	6-8-10-12-16-20-25	7	9,09	



Zubehör / Accessories / Accessoires / Yedekler

	Spannzangen Collets Pincés de serrage Pens		Rollenschlüssel für Spannmutter Roller Bearing Wrenches Cles à rouleaux Bilyalı Kapak Sıkma Anahtarı	
10.19		10.47		11.02

- Lieferumfang : Spannfutter, inkl. Spannzangen mit Schlüssel
Included : Collet chuck with collets and wrench
Inclus : Mandrin avec pincés et clé
Teslim Şekli : Tutucu, pensleri ve anahtarlarıyla birlikte



Fräseraufnahmen

End mill holder

Porte-fraises

Veldon tutucu

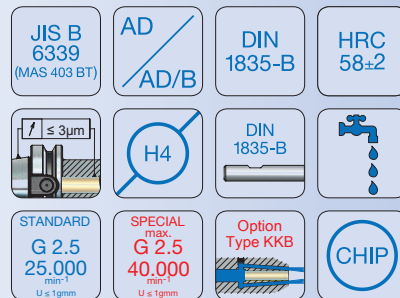

Bestell-Nr. Order Nr. Reference Sipariş Nr.	BT	Form	d	A	D	D1	L1	L2	Kg	Euro
305.04.06.50	BT 30	AD	6	50	25	-	-	36	0,46	
305.04.08.50	BT 30	AD	8	50	28	-	-	40	0,49	
305.04.10.50	BT 30	AD	10	50	35	-	-	44	0,54	
305.04.12.50	BT 30	AD	12	50	42	-	-	51	0,60	
305.04.14.50	BT 30	AD	14	50	44	-	-	51	0,61	
305.04.16.63	BT 30	AD	16	63	48	-	-	54	0,81	
305.04.18.63	BT 30	AD	18	63	50	-	-	54	0,82	
•305.04.20.63	BT 30	AD	20	63	52	-	-	56	0,81	
405.04.06.50	BT 40	AD	6	50	25	-	-	36	1,03	
406.04.06.50	BT 40	AD/B	6	50	25	-	-	36	1,03	
405.04.06.100	BT 40	AD	6	100	25	-	-	36	1,20	
406.04.06.100	BT 40	AD/B	6	100	25	-	-	36	1,20	
405.04.06.130	BT 40	AD	6	130	25	-	-	36	1,31	
406.04.06.130	BT 40	AD/B	6	130	25	-	-	36	1,30	
405.04.06.160	BT 40	AD	6	160	25	29,5	88	36	1,44	
406.04.06.160	BT 40	AD/B	6	160	25	29,5	88	36	1,44	
406.04.06.200	BT 40	AD/B	6	200	25	30	120	36	1,60	
405.04.08.50	BT 40	AD	8	50	28	-	-	40	1,05	
406.04.08.50	BT 40	AD/B	8	50	28	-	-	40	1,05	
405.04.08.100	BT 40	AD	8	100	28	-	-	40	1,27	
406.04.08.100	BT 40	AD/B	8	100	28	-	-	40	1,27	
405.04.08.130	BT 40	AD	8	130	28	-	-	40	1,41	
406.04.08.130	BT 40	AD/B	8	130	28	-	-	40	1,40	
405.04.08.160	BT 40	AD	8	160	28	32,5	88	40	1,58	
406.04.08.160	BT 40	AD/B	8	160	28	32,5	88	40	1,57	
406.04.08.200	BT 40	AD/B	8	200	28	33	120	40	1,77	

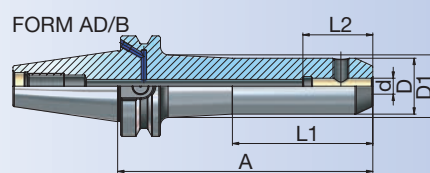
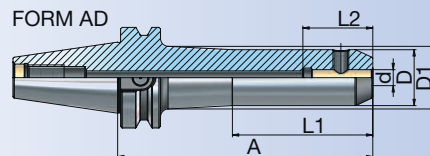

- Technisch gibt es keinen Chip.
- Technically there is no chip hole.
- Techniquement, il n'y a pas de puce.
- Teknik açıdan çip deliği bulunmamaktadır.

Zubehör / Accessories / Accessoires / Yedekler



Spannschrauben
Clamping screw
Vis de serrage
Sıkma civatası



11.05

Fräseraufnahmen

End mill holder

Porte-fraises

Veldon tutucu

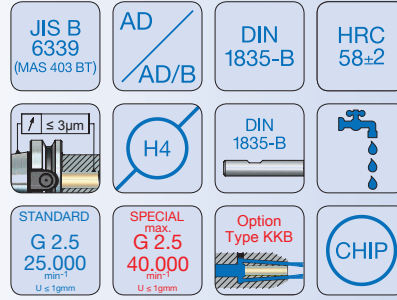

JIS B 6339
(MAS 403 BT)

Bestell-Nr. Order Nr. Reference Sipariş Nr.	BT	Form	d	A	D	D1	L1	L2	Kg	Euro
405.04.10.63	BT 40	AD	10	63	35	-	-	44	1,17	
406.04.10.63	BT 40	AD/B	10	63	35	-	-	44	1,17	
405.04.10.100	BT 40	AD	10	100	35	-	-	44	1,42	
406.04.10.100	BT 40	AD/B	10	100	35	-	-	44	1,41	
405.04.10.130	BT 40	AD	10	130	35	-	-	44	1,62	
406.04.10.130	BT 40	AD/B	10	130	35	-	-	44	1,61	
405.04.10.160	BT 40	AD	10	160	35	39,5	88	44	1,86	
406.04.10.160	BT 40	AD/B	10	160	35	39,5	88	44	1,86	
406.04.10.200	BT 40	AD/B	10	200	35	40,5	120	44	2,14	
405.04.12.63	BT 40	AD	12	63	42	-	-	51	1,26	
406.04.12.63	BT 40	AD/B	12	63	42	-	-	51	1,26	
405.04.12.100	BT 40	AD	12	100	42	-	-	51	1,63	
406.04.12.100	BT 40	AD/B	12	100	42	-	-	51	1,62	
405.04.12.130	BT 40	AD	12	130	42	-	-	51	1,93	
406.04.12.130	BT 40	AD/B	12	130	42	-	-	51	1,92	
405.04.12.160	BT 40	AD	12	160	42	46,5	88	51	2,28	
406.04.12.160	BT 40	AD/B	12	160	42	46,5	88	51	2,28	
406.04.12.200	BT 40	AD/B	12	200	42	47,5	120	51	2,70	
405.04.14.63	BT 40	AD	14	63	44	-	-	51	1,28	
406.04.14.63	BT 40	AD/B	14	63	44	-	-	51	1,28	
405.04.14.100	BT 40	AD	14	100	44	-	-	51	1,69	
406.04.14.100	BT 40	AD/B	14	100	44	-	-	51	1,68	
405.04.14.130	BT 40	AD	14	130	44	-	-	51	2,02	
406.04.14.130	BT 40	AD/B	14	130	44	-	-	51	2,01	
405.04.14.160	BT 40	AD	14	160	44	48,5	88	51	2,40	
406.04.14.160	BT 40	AD/B	14	160	44	48,5	88	51	2,40	
406.04.14.200	BT 40	AD/B	14	200	44	49,5	120	51	2,86	

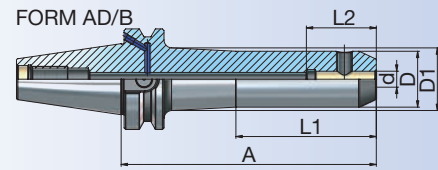
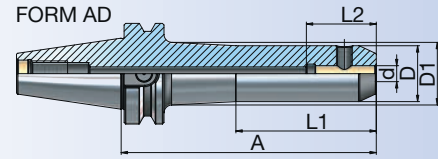

Zubehör / Accessories / Accessoires / Yedekler



Spannschrauben
Clamping screw
Vis de serrage
Sıkma civatası



11.05



Fräseraufnahmen

End mill holder

Porte-fraises

Veldon tutucu

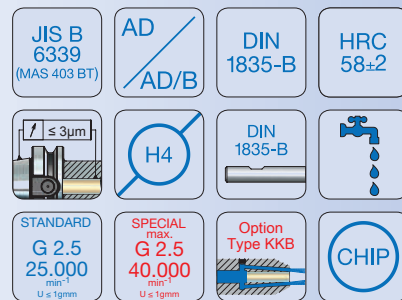

Bestell-Nr. Order Nr. Reference Sipariş Nr.	BT	Form	d	A	D	D1	L1	L2	Kg	Euro
•405.04.16.35	BT 40	AD	16	35	45	-	-	54	0,97	
405.04.16.63	BT 40	AD	16	63	48	-	-	54	1,34	
406.04.16.63	BT 40	AD/B	16	63	48	-	-	54	1,33	
405.04.16.100	BT 40	AD	16	100	48	-	-	54	1,82	
406.04.16.100	BT 40	AD/B	16	100	48	-	-	54	1,82	
405.04.16.130	BT 40	AD	16	130	48	-	-	54	2,23	
406.04.16.130	BT 40	AD/B	16	130	48	-	-	54	2,22	
405.04.16.160	BT 40	AD	16	160	48	52,5	88	54	2,68	
406.04.16.160	BT 40	AD/B	16	160	48	52,5	88	54	2,68	
406.04.16.200	BT 40	AD/B	16	200	48	53,5	120	54	3,23	
405.04.18.63	BT 40	AD	18	63	50	-	-	54	1,35	
406.04.18.63	BT 40	AD/B	18	63	50	-	-	54	1,35	
405.04.18.100	BT 40	AD	18	100	50	-	-	54	1,89	
406.04.18.100	BT 40	AD/B	18	100	50	-	-	54	1,88	
405.04.18.130	BT 40	AD	18	130	50	-	-	54	2,32	
406.04.18.130	BT 40	AD/B	18	130	50	-	-	54	2,31	
405.04.18.160	BT 40	AD	18	160	50	54,5	88	54	2,82	
406.04.18.160	BT 40	AD/B	18	160	50	54,5	88	54	2,81	
406.04.18.200	BT 40	AD/B	18	200	50	55,5	120	54	3,42	
•405.04.20.35	BT 40	AD	20	35	45	-	-	56	0,92	
405.04.20.63	BT 40	AD	20	63	52	-	-	56	1,36	
406.04.20.63	BT 40	AD/B	20	63	52	-	-	56	1,36	
405.04.20.100	BT 40	AD	20	100	52	-	-	56	1,94	
406.04.20.100	BT 40	AD/B	20	100	52	-	-	56	1,94	
405.04.20.130	BT 40	AD	20	130	52	-	-	56	2,41	
406.04.20.130	BT 40	AD/B	20	130	52	-	-	56	2,41	
405.04.20.160	BT 40	AD	20	160	52	57	88	56	2,95	
406.04.20.160	BT 40	AD/B	20	160	52	57	88	56	2,95	
406.04.20.200	BT 40	AD/B	20	200	52	57,5	120	56	3,60	

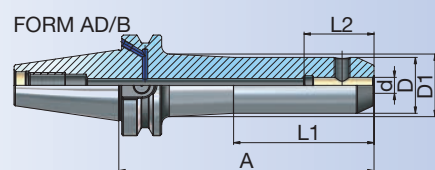
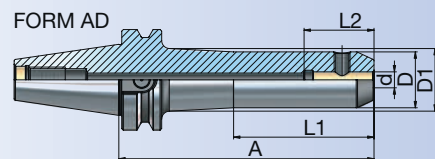

- Technisch gibt es keinen Chip.
- Technically there is no chip hole.
- Techniquement, il n'y a pas de puce.
- Teknik açıdan çip deliği bulunmamaktadır.

Zubehör / Accessories / Accessoires / Yedekler



Spannschrauben
Clamping screw
Vis de serrage
Sıkma civatası



11.05

Fräseraufnahmen

End mill holder

Porte-fraises

Veldon tutucu

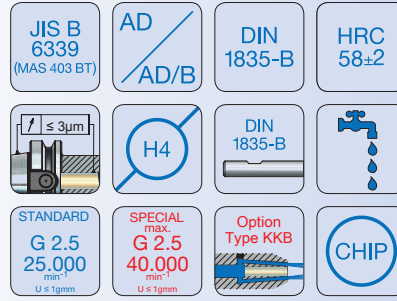

JIS B 6339
(MAS 403 BT)

Bestell-Nr. Order Nr. Reference Sipariş Nr.	BT	Form	d	A	D	D1	L1	L2	Kg	Euro
•405.04.25.35	BT 40	AD	25	35	45	-	-	64	0,84	
405.04.25.90	BT 40	AD	25	90	63	-	-	64	2,12	
406.04.25.90	BT 40	AD/B	25	90	63	-	-	64	2,11	
405.04.25.130	BT 40	AD	25	130	63	-	-	64	3,06	
406.04.25.130	BT 40	AD/B	25	130	63	-	-	64	3,05	
405.04.25.160	BT 40	AD	25	160	63	-	-	64	3,76	
406.04.25.160	BT 40	AD/B	25	160	63	-	-	64	3,75	
406.04.25.200	BT 40	AD/B	25	200	63	-	-	64	4,69	
•405.04.32.65	BT 40	AD	32	65	62	-	-	68	1,41	
405.04.32.100	BT 40	AD	32	100	72	-	-	68	2,65	
406.04.32.100	BT 40	AD/B	32	100	72	-	-	68	2,64	
405.04.32.130	BT 40	AD	32	130	72	-	-	68	3,56	
406.04.32.130	BT 40	AD/B	32	130	72	-	-	68	3,55	
405.04.32.160	BT 40	AD	32	160	72	-	-	68	4,48	
406.04.32.160	BT 40	AD/B	32	160	72	-	-	68	4,48	
405.04.40.120	BT 40	AD	40	120	80	-	-	78	3,49	
406.04.40.120	BT 40	AD/B	40	120	80	-	-	78	3,48	

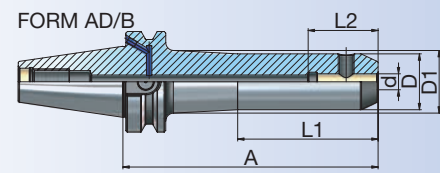
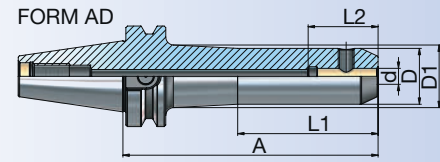

- Technisch gibt es keinen Chip.
- Technically there is no chip hole.
- Techniquement, il n'y a pas de puce.
- Teknik açıdan çip deliği bulunmamaktadır.

Zubehör / Accessories / Accessoires / Yedekler



Spannschrauben
Clamping screw
Vis de serrage
Sıkma civatası



11.05



Fräseraufnahmen

End mill holder

Porte-fraises

Veldon tutucu

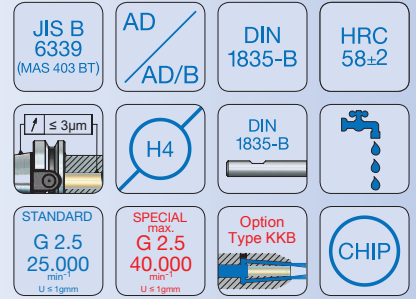

Bestell-Nr. Order Nr. Reference Sipariş Nr.	BT	Form	d	A	D	D1	L1	L2	Kg	Euro
505.04.06.63	BT 50	AD	6	63	25	-	-	36	3,70	
506.04.06.63	BT 50	AD/B	6	63	25	-	-	36	3,69	
505.04.06.100	BT 50	AD	6	100	25	-	-	36	3,83	
506.04.06.100	BT 50	AD/B	6	100	25	-	-	36	3,81	
505.04.06.130	BT 50	AD	6	130	25	-	-	36	3,93	
506.04.06.130	BT 50	AD/B	6	130	25	-	-	36	3,91	
505.04.06.160	BT 50	AD	6	160	25	28,5	88	36	4,05	
506.04.06.160	BT 50	AD/B	6	160	25	28,5	88	36	4,04	
506.04.06.200	BT 50	AD/B	6	200	25	28,5	120	36	4,19	
505.04.08.63	BT 50	AD	8	63	28	-	-	40	3,72	
506.04.08.63	BT 50	AD/B	8	63	28	-	-	40	3,71	
505.04.08.100	BT 50	AD	8	100	28	-	-	40	3,88	
506.04.08.100	BT 50	AD/B	8	100	28	-	-	40	3,87	
505.04.08.130	BT 50	AD	8	130	28	-	-	40	4,02	
506.04.08.130	BT 50	AD/B	8	130	28	-	-	40	4,00	
505.04.08.160	BT 50	AD	8	160	28	31,5	88	40	4,17	
506.04.08.160	BT 50	AD/B	8	160	28	31,5	88	40	4,15	
506.04.08.200	BT 50	AD/B	8	200	28	31,5	120	40	4,35	
505.04.10.63	BT 50	AD	10	63	35	-	-	44	3,74	
506.04.10.63	BT 50	AD/B	10	63	35	-	-	44	3,73	
505.04.10.100	BT 50	AD	10	100	35	-	-	44	3,99	
506.04.10.100	BT 50	AD/B	10	100	35	-	-	44	3,97	
505.04.10.130	BT 50	AD	10	130	35	-	-	44	4,19	
506.04.10.130	BT 50	AD/B	10	130	35	-	-	44	4,18	
505.04.10.160	BT 50	AD	10	160	35	38,5	88	44	4,42	
506.04.10.160	BT 50	AD/B	10	160	35	38,5	88	44	4,40	
506.04.10.200	BT 50	AD/B	10	200	35	38,5	120	44	4,70	

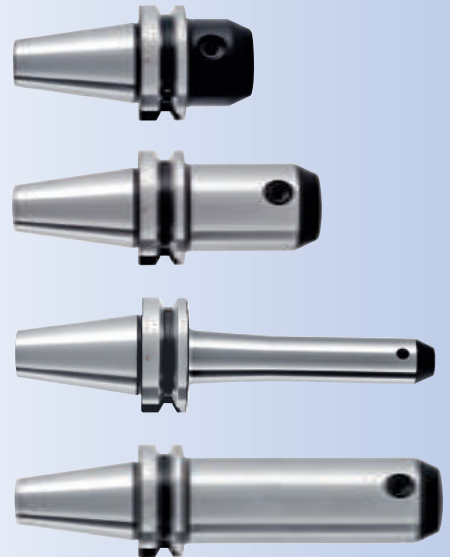
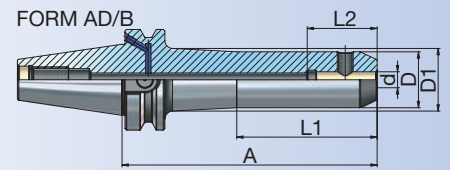
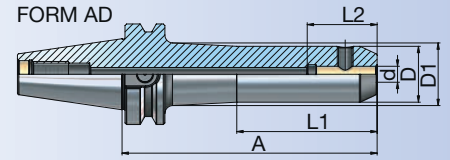

Zubehör / Accessories / Accessoires / Yedekler

DIN 1835 B



10.38

Spannschrauben
Clamping screw
Vis de serrage
Sikma civatası



11.05

Fräseraufnahmen

End mill holder

Porte-fraises

Veldon tutucu

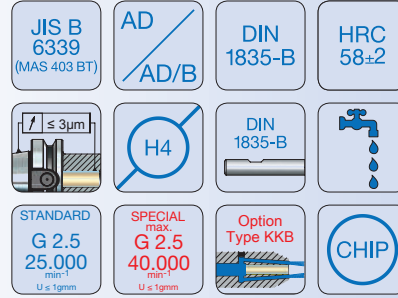

JIS B 6339
(MAS 403 BT)

Bestell-Nr. Order Nr. Reference Sipariş Nr.	BT	Form	d	A	D	D1	L1	L2	Kg	Euro
505.04.12.80	BT 50	AD	12	80	42	-	-	51	3,97	
506.04.12.80	BT 50	AD/B	12	80	42	-	-	51	3,95	
505.04.12.100	BT 50	AD	12	100	42	-	-	51	4,17	
506.04.12.100	BT 50	AD/B	12	100	42	-	-	51	4,15	
505.04.12.130	BT 50	AD	12	130	42	-	-	51	4,47	
506.04.12.130	BT 50	AD/B	12	130	42	-	-	51	4,47	
505.04.12.160	BT 50	AD	12	160	42	45,5	88	51	4,80	
506.04.12.160	BT 50	AD/B	12	160	42	45,5	88	51	4,78	
506.04.12.200	BT 50	AD/B	12	200	42	45,5	120	51	5,21	
505.04.14.80	BT 50	AD	14	80	44	-	-	51	3,99	
506.04.14.80	BT 50	AD/B	14	80	44	-	-	51	3,98	
505.04.14.100	BT 50	AD	14	100	44	-	-	51	4,21	
506.04.14.100	BT 50	AD/B	14	100	44	-	-	51	4,20	
505.04.14.130	BT 50	AD	14	130	44	-	-	51	4,55	
506.04.14.130	BT 50	AD/B	14	130	44	-	-	51	4,54	
505.04.14.160	BT 50	AD	14	160	44	47,5	88	51	4,91	
506.04.14.160	BT 50	AD/B	14	160	44	47,5	88	51	4,89	
506.04.14.200	BT 50	AD/B	14	200	44	47,5	120	51	5,36	
505.04.16.80	BT 50	AD	16	80	48	-	-	54	4,06	
506.04.16.80	BT 50	AD/B	16	80	48	-	-	54	4,05	
505.04.16.100	BT 50	AD	16	100	48	-	-	54	4,33	
506.04.16.100	BT 50	AD/B	16	100	48	-	-	54	4,31	
505.04.16.130	BT 50	AD	16	130	48	-	-	54	4,73	
506.04.16.130	BT 50	AD/B	16	130	48	-	-	54	4,71	
505.04.16.160	BT 50	AD	16	160	48	51,5	88	54	5,16	
506.04.16.160	BT 50	AD/B	16	160	48	51,5	88	54	5,14	
506.04.16.200	BT 50	AD/B	16	200	48	51,5	120	54	5,71	

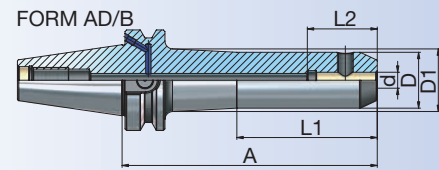
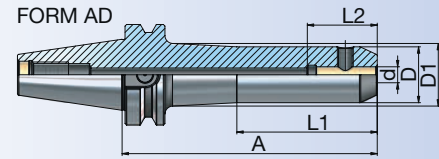

Zubehör / Accessories / Accessoires / Yedekler



Spannschrauben
Clamping screw
Wis de serrage
Sıkma civatası



11.05



Fräseraufnahmen

End mill holder

Porte-fraises

Veldon tutucu

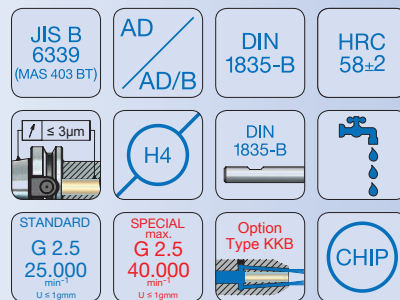

Bestell-Nr. Order Nr. Reference Sipariş Nr.	BT	Form	d	A	D	D1	L1	L2	Kg	Euro
505.04.18.80	BT 50	AD	18	80	50	-	-	54	4,09	
506.04.18.80	BT 50	AD/B	18	80	50	-	-	54	4,07	
505.04.18.100	BT 50	AD	18	100	50	-	-	54	4,38	
506.04.18.100	BT 50	AD/B	18	100	50	-	-	54	4,36	
505.04.18.130	BT 50	AD	18	130	50	-	-	54	4,81	
506.04.18.130	BT 50	AD/B	18	130	50	-	-	54	4,79	
505.04.18.160	BT 50	AD	18	160	50	53,5	88	54	5,28	
506.04.18.160	BT 50	AD/B	18	160	50	53,5	88	54	5,26	
506.04.18.200	BT 50	AD/B	18	200	50	53,5	120	54	5,88	
505.04.20.80	BT 50	AD	20	80	52	-	-	56	4,10	
506.04.20.80	BT 50	AD/B	20	80	52	-	-	56	4,09	
505.04.20.100	BT 50	AD	20	100	52	-	-	56	4,42	
506.04.20.100	BT 50	AD/B	20	100	52	-	-	56	4,40	
505.04.20.130	BT 50	AD	20	130	52	-	-	56	4,89	
506.04.20.130	BT 50	AD/B	20	130	52	-	-	56	4,87	
505.04.20.160	BT 50	AD	20	160	52	55,5	88	56	5,40	
506.04.20.160	BT 50	AD/B	20	160	52	55,5	88	56	5,38	
506.04.20.200	BT 50	AD/B	20	200	52	55,5	120	56	6,05	
505.04.25.100	BT 50	AD	25	100	63	-	-	64	4,76	
506.04.25.100	BT 50	AD/B	25	100	63	-	-	64	4,74	
505.04.25.120	BT 50	AD	25	120	63	-	-	64	5,23	
506.04.25.120	BT 50	AD/B	25	120	63	-	-	64	5,21	
505.04.25.130	BT 50	AD	25	130	63	-	-	64	5,47	
506.04.25.130	BT 50	AD/B	25	130	63	-	-	64	5,45	
505.04.25.160	BT 50	AD	25	160	63	66,5	88	64	6,22	
506.04.25.160	BT 50	AD/B	25	160	63	66,5	88	64	6,20	

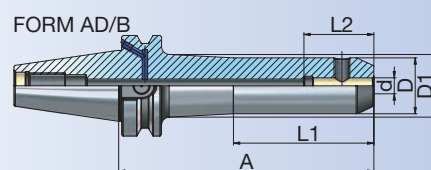
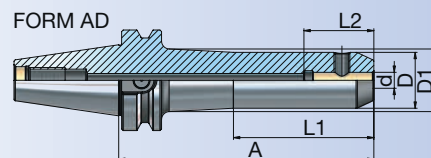

Zubehör / Accessories / Accessoires / Yedekler



Spannschrauben
Clamping screw
Vis de serrage
Sıkma civatası



Fräseraufnahmen

End mill holder

Porte-fraises

Veldon tutucu

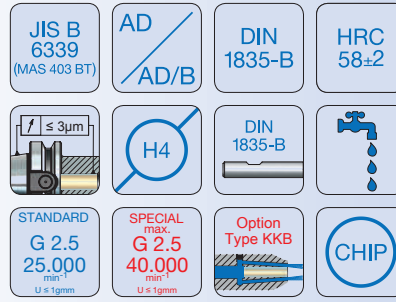

JIS B 6339
(MAS 403 BT)

Bestell-Nr. Order Nr. Reference Sipariş Nr.	BT	Form	d	A	D	D1	L1	L2	Kg	Euro
505.04.32.105	BT 50	AD	32	105	72	-	-	68	5,18	
506.04.32.105	BT 50	AD/B	32	105	72	-	-	68	5,17	
505.04.32.130	BT 50	AD	32	130	72	-	-	68	5,96	
506.04.32.130	BT 50	AD/B	32	130	72	-	-	68	5,94	
505.04.32.160	BT 50	AD	32	160	72	-	-	68	6,89	
506.04.32.160	BT 50	AD/B	32	160	72	-	-	68	6,87	
505.04.40.110	BT 50	AD	40	110	80	-	-	78	5,49	
506.04.40.110	BT 50	AD/B	40	110	80	-	-	78	5,48	
505.04.40.130	BT 50	AD	40	130	80	-	-	78	6,27	
506.04.40.130	BT 50	AD/B	40	130	80	-	-	78	6,26	
505.04.40.160	BT 50	AD	40	160	80	-	-	78	7,42	
506.04.40.160	BT 50	AD/B	40	160	80	-	-	78	7,40	

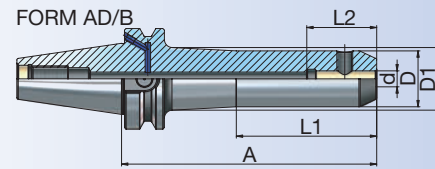
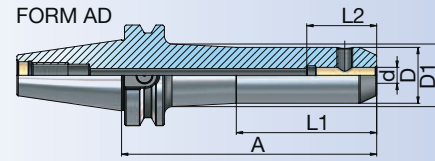

Zubehör / Accessories / Accessoires / Yedekler



Spannschrauben
Clamping screw
Vis de serrage
Sıkma civatası





Fräseraufnahmen mit Kühlkanal

End mill holder with coolant channel

Porte-fraises avec canal d'arrosage

Veldon tutucu için soğutma kanallı

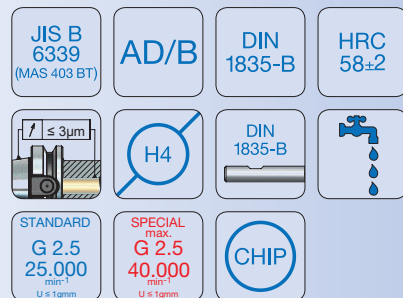

Bestell-Nr. Order Nr. Reference Sipariş Nr.	BT	Form	d	A	D	L2	Kg	Euro
406.04.06.50.K	BT 40	AD/B	6	50	25	36	1,03	
406.04.06.100.K	BT 40	AD/B	6	100	25	36	1,20	
406.04.08.50.K	BT 40	AD/B	8	50	28	40	1,05	
406.04.08.100.K	BT 40	AD/B	8	100	28	40	1,27	
406.04.10.63.K	BT 40	AD/B	10	63	35	44	1,16	
406.04.10.100.K	BT 40	AD/B	10	100	35	44	1,41	
406.04.12.63.K	BT 40	AD/B	12	63	42	51	1,25	
406.04.12.100.K	BT 40	AD/B	12	100	42	51	1,62	
406.04.14.63.K	BT 40	AD/B	14	63	44	51	1,27	
406.04.14.100.K	BT 40	AD/B	14	100	44	51	1,68	
406.04.16.63.K	BT 40	AD/B	16	63	48	54	1,32	
406.04.16.100.K	BT 40	AD/B	16	100	48	54	1,81	
406.04.18.63.K	BT 40	AD/B	18	63	50	54	1,34	
406.04.18.100.K	BT 40	AD/B	18	100	50	54	1,87	
•406.04.20.63.K	BT 40	AD/B	20	63	52	56	1,35	
406.04.20.100.K	BT 40	AD/B	20	100	52	56	1,92	
406.04.25.90.K	BT 40	AD/B	25	90	63	64	2,09	
406.04.32.100.K	BT 40	AD/B	32	100	72	68	2,62	
406.04.40.120.K	BT 40	AD/B	40	120	80	78	3,46	

506.04.06.63.K	BT 50	AD/B	6	63	25	36	3,68	
506.04.08.63.K	BT 50	AD/B	8	63	28	40	3,70	
506.04.10.63.K	BT 50	AD/B	10	63	35	44	3,72	
506.04.12.80.K	BT 50	AD/B	12	80	42	51	3,95	
506.04.14.80.K	BT 50	AD/B	14	80	44	51	3,97	
506.04.16.80.K	BT 50	AD/B	16	80	48	54	4,03	
506.04.18.80.K	BT 50	AD/B	18	80	50	54	4,06	
506.04.20.80.K	BT 50	AD/B	20	80	52	56	4,07	
506.04.25.100.K	BT 50	AD/B	25	100	63	64	4,72	
506.04.32.105.K	BT 50	AD/B	32	105	72	68	5,14	
506.04.40.110.K	BT 50	AD/B	40	110	80	78	5,45	

FORM AD/B

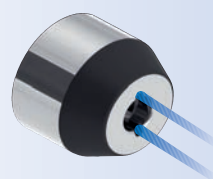
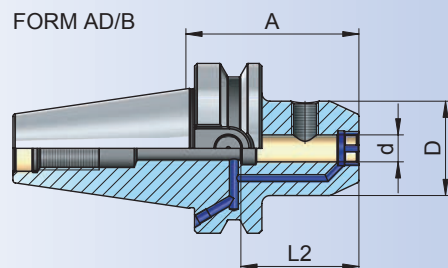

d
6 - 18
(2 Holes)
(2 Delik)

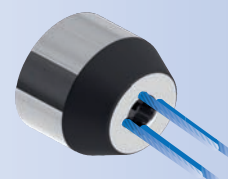

d
20 - 40
(4 Holes)
(4 Delik)

- Technisch gibt es keinen Chip.
- Technically there is no chip hole.
- Techniquement, il n'y a pas de puce.
- Teknik açıdan çip deliği bulunmamaktadır.

Zubehör / Accessories / Accessoires / Yedekler



Spannschrauben
Clamping screw
Vis de serrage
Sıkma civatası



11.05

Fräseraufnahmen 2° Whistle-Notch



End mill holder 2°

Porte-fraises 2°

Veldon tutucu 2°

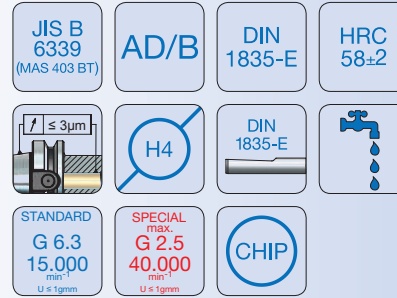

JIS B 6339
(MAS 403 BT)

Bestell-Nr. Order Nr. Reference Sipariş Nr.	BT	Form	d	A	D	L2	Kg	Euro
406.05.06.50	BT 40	AD/B	6	50	25	36	1,04	
406.05.08.50	BT 40	AD/B	8	50	28	40	1,06	
406.05.10.63	BT 40	AD/B	10	63	35	44	1,18	
406.05.12.63	BT 40	AD/B	12	63	42	51	1,27	
406.05.14.63	BT 40	AD/B	14	63	44	51	1,29	
406.05.16.63	BT 40	AD/B	16	63	48	54	1,35	
406.05.18.63	BT 40	AD/B	18	63	50	54	1,36	
406.05.20.63	BT 40	AD/B	20	63	52	56	1,37	
406.05.25.90	BT 40	AD/B	25	90	63	64	2,12	
406.05.32.100	BT 40	AD/B	32	100	72	68	2,65	
406.05.40.120	BT 40	AD/B	40	120	80	78	3,50	

FORM AD/B

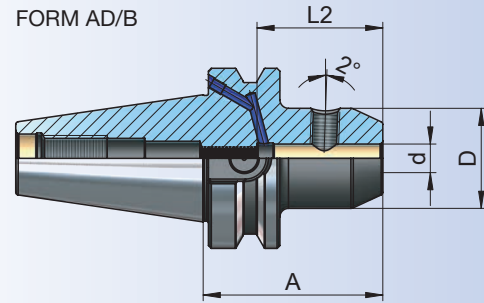

506.05.06.63	BT 50	AD/B	6	63	25	36	3,69	
506.05.08.63	BT 50	AD/B	8	63	28	40	3,71	
506.05.10.63	BT 50	AD/B	10	63	35	44	3,74	
506.05.12.80	BT 50	AD/B	12	80	42	51	3,97	
506.05.14.80	BT 50	AD/B	14	80	44	51	3,99	
506.05.16.80	BT 50	AD/B	16	80	48	54	4,06	
506.05.18.80	BT 50	AD/B	18	80	50	54	4,08	
506.05.20.80	BT 50	AD/B	20	80	52	56	4,10	
506.05.25.100	BT 50	AD/B	25	100	63	64	4,75	
506.05.32.105	BT 50	AD/B	32	105	72	68	5,18	
506.05.40.110	BT 50	AD/B	40	110	80	78	5,50	

Zubehör / Accessories / Accessoires / Yedekler

DIN 1835 B



10.38

Spannschrauben
Clamping screw
Vis de serrage
Sıkma civatası

DIN 916



10.41-10.43

Einstellschraube
Adjusting screw
Vis de réglage
Dayama civatası



Hochgenauigkeits-Spannzangenfutter

High precision pull type collet chuck

Mandrin de serrage de précision

Hassas çekilmeli pens başlığı

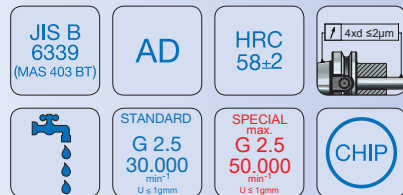

Bestell-Nr. Order Nr. Reference Sipariş Nr.	BT	Form	Spannbereich Capacity Capacité Kapasite	A	D	D1	L	L1	Kg	Euro
new 405.06.06.115	BT 40	AD	EPC (3-6)	115	14	-	50	-	1,59	
new 405.06.06.140	BT 40	AD	EPC (3-6)	140	14	16,7	75	40	1,64	
new 405.06.06.165	BT 40	AD	EPC (3-6)	165	14	19,3	100	40	1,69	
new 405.06.06.215	BT 40	AD	EPC (3-6)	215	14	24,8	150	40	1,83	
new 405.06.08.115	BT 40	AD	EPC (3-8)	115	20	-	50	-	1,64	
new 405.06.08.140	BT 40	AD	EPC (3-8)	140	20	22,9	75	40	1,72	
new 405.06.08.165	BT 40	AD	EPC (3-8)	165	20	25,7	100	40	1,81	
new 405.06.08.215	BT 40	AD	EPC (3-8)	215	20	31,2	150	40	2,06	
new 405.06.12.140	BT 40	AD	EPC (3-12)	140	26	28,1	75	50	1,78	
new 405.06.12.165	BT 40	AD	EPC (3-12)	165	26	30,9	100	50	1,90	
new 405.06.12.215	BT 40	AD	EPC (3-12)	215	26	34,7	150	50	2,20	
new 405.06.16.140	BT 40	AD	EPC (3-16)	140	30	-	75	-	1,80	
new 405.06.16.165	BT 40	AD	EPC (3-16)	165	30	34,1	100	60	1,97	
new 405.06.16.215	BT 40	AD	EPC (3-16)	215	30	34,7	150	60	2,29	

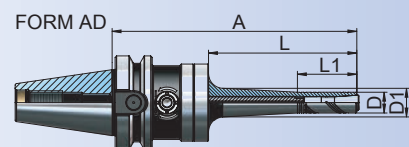

Spannzangen Größe Collet size Diamètre de pince Pens ölçüsü (mm)	Max. Anzugskraft Max. Clamping torque Couple max. Max. Sıkma torku (Nm)	Max. Haltekraft Max. Holding torque Force de serrage Max. Tutma torku (Nm)
EPC 6 (Ø3-Ø6)	4	16
EPC 8 (Ø3-Ø8)	15	50
EPC 12 (Ø3-Ø12)	20	160
EPC 16 (Ø3-Ø16)	25	260

Zubehör / Accessories / Accessoires / Yedekler

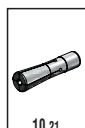

Spannzangen
Collets
Pincettes de serrage
Pens



Spannschlüssel
Wrench
Clé de serrage
Sıkma anahtarı





Hochgenauigkeits-Spannzangenfutter

High precision pull type collet chuck

Mandrin de serrage de précision

Hassas çektiirmeli pens başlığı

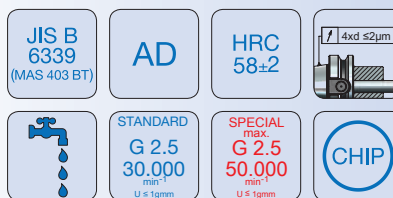

Bestell-Nr. Order Nr. Reference Sipariş Nr.	BT	Form	Spannbereich Capacity Capacité Kapasite	A	D	D1	L	L1	Kg	Euro
new 505.06.06.125	BT 50	AD	EPC (3-6)	125	14	-	50	-	4,22	
new 505.06.06.150	BT 50	AD	EPC (3-6)	150	14	16,7	75	40	4,26	
new 505.06.06.175	BT 50	AD	EPC (3-6)	175	14	19,3	100	40	4,31	
new 505.06.06.225	BT 50	AD	EPC (3-6)	225	14	24,8	150	40	4,46	
new 505.06.08.125	BT 50	AD	EPC (3-8)	125	20	-	50	-	4,27	
new 505.06.08.150	BT 50	AD	EPC (3-8)	150	20	22,9	75	40	4,34	
new 505.06.08.175	BT 50	AD	EPC (3-8)	175	20	25,7	100	40	4,43	
new 505.06.08.225	BT 50	AD	EPC (3-8)	225	20	31,2	150	40	4,68	
new 505.06.12.150	BT 50	AD	EPC (3-12)	150	26	28,1	75	50	4,40	
new 505.06.12.175	BT 50	AD	EPC (3-12)	175	26	30,9	100	50	4,53	
new 505.06.12.225	BT 50	AD	EPC (3-12)	225	26	34,7	150	50	4,83	
new 505.06.16.150	BT 50	AD	EPC (3-16)	150	30	-	75	-	4,42	
new 505.06.16.175	BT 50	AD	EPC (3-16)	175	30	34,1	100	60	4,59	
new 505.06.16.225	BT 50	AD	EPC (3-16)	225	30	34,7	150	60	4,91	

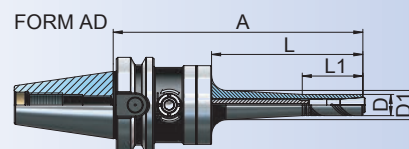

Spannzangen Größe Collet size Diamètre de pince Pens ölçüsü (mm)	Max. Anzugskraft Max. Clamping torque Couple max. Max. Sıkma torku (Nm)	Max. Haltekraft Max. Holding torque Force de serrage Max. Tutma torku (Nm)
EPC 6 (Ø3-Ø6)	4	16
EPC 8 (Ø3-Ø8)	15	50
EPC 12 (Ø3-Ø12)	20	160
EPC 16 (Ø3-Ø16)	25	260

Zubehör / Accessories / Accessoires / Yedekler

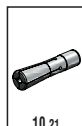

Spannzangen
Collets
Pincés de serrage
Pens

10.21



Spannschlüssel
Wrench
Clé de serrage
Sıkma anahtarı

10.49



11.12

JIS B 6339
(MAS 403 BT)



Hochgenauigkeits-Spannzangenfutter im Koffer

High precision pull type collet chuck set in box

Mandrin de serrage de précision (set) dans coffre

Hassas çekilmeli pens başlığı seti plastik kutuda

JIS B
6339
(MAS 403 BT)

AD

HRC
58±2



Bestell-Nr. Order Nr. Reference Sipariş Nr.	BT	Form	Spannbereich Capacity Capacité Kapasite	Spannzangen Durchmesser Collet Diameter Pinces Diamètre Pens Çapı	Spannzangen Stk. Collet Pcs. Pinces Pens Adedi	Kg	Euro
new 405.67.06.115	BT 40	AD	EPC (3 - 6)	3-4-5-6	4	2,55	
new 405.67.08.115	BT 40	AD	EPC (3 - 8)	3-4-5-6-8	5	2,68	
new 405.67.12.140	BT 40	AD	EPC (3 - 12)	6-8-10-12	5	2,90	
new 405.67.16.140	BT 40	AD	EPC (3 - 16)	6-8-10-12-16	5	3,26	
new 505.67.06.125	BT 50	AD	EPC (3 - 6)	3-4-5-6	4	5,18	
new 505.67.08.125	BT 50	AD	EPC (3 - 8)	3-4-5-6-8	5	5,31	
new 505.67.12.150	BT 50	AD	EPC (3 - 12)	6-8-10-12	5	5,52	
new 505.67.16.150	BT 50	AD	EPC (3 - 16)	6-8-10-12-16	5	5,88	



Lieferumfang : Spannfutter, inkl. Spannzangen mit Schlüssel
Included : Collet chuck with collets and wrench
Inclus : Mandrin avec pinces et clé
Teslim Şekli : Tutucu, pensleri ve anahtarıyla birlikte

Zubehör / Accessories / Accessoires / Yedekler

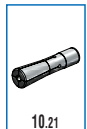

Spannzangen
Collets
Pinces de serrage
Pens



Spannschlüssel
Wrench
Clé de serrage
Sıkma anahtarı



Morsekegel-Aufnahmen mit Austreibblappen



Morse taper adaptor

Douilles intermédiaires pour outils à cône Morse

Mors adaptörü

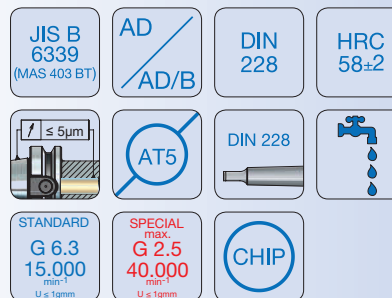

Bestell-Nr. Order Nr. Reference Sipariş Nr.	BT	Form	MK	A	D	Kg	Euro
305.07.01.45	BT 30	AD	MK 1	45	25	0,42	
305.07.02.60	BT 30	AD	MK 2	60	32	0,49	
305.07.03.75	BT 30	AD	MK 3	75	40	0,63	

405.07.01.50	BT 40	AD	MK 1	50	25	1,00	
406.07.01.50	BT 40	AD/B	MK 1	50	25	0,99	
405.07.02.50	BT 40	AD	MK 2	50	32	0,99	
406.07.02.50	BT 40	AD/B	MK 2	50	32	0,98	
405.07.02.117	BT 40	AD	MK 2	117	32	1,38	
405.07.03.70	BT 40	AD	MK 3	70	40	1,11	
406.07.03.70	BT 40	AD/B	MK 3	70	40	1,10	
405.07.03.135	BT 40	AD	MK 3	135	40	1,70	
405.07.04.95	BT 40	AD	MK 4	95	48	1,32	
406.07.04.95	BT 40	AD/B	MK 4	95	48	1,27	
405.07.04.160	BT 40	AD	MK 4	160	48	2,17	

505.07.01.45	BT 50	AD	MK 1	45	25	3,54	
506.07.01.45	BT 50	AD/B	MK 1	45	25	3,52	
505.07.02.60	BT 50	AD	MK 2	60	32	3,57	
506.07.02.60	BT 50	AD/B	MK 2	60	32	3,55	
505.07.02.125	BT 50	AD	MK 2	125	32	3,99	
505.07.03.65	BT 50	AD	MK 3	65	40	3,54	
506.07.03.65	BT 50	AD/B	MK 3	65	40	3,52	
505.07.03.147	BT 50	AD	MK 3	147	40	4,34	
505.07.04.95	BT 50	AD	MK 4	95	48	3,75	
506.07.04.95	BT 50	AD/B	MK 4	95	48	3,72	
505.07.04.170	BT 50	AD	MK 4	170	48	4,78	
505.07.05.105	BT 50	AD	MK 5	105	63	3,72	
506.07.05.105	BT 50	AD/B	MK 5	105	63	3,69	
505.07.05.205	BT 50	AD	MK 5	205	63	6,00	

FORM AD

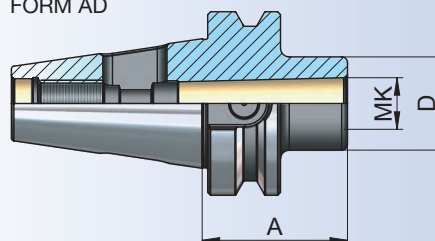

FORM AD/B

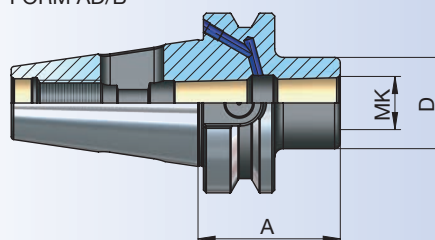



Zwischenhülsen für MK mit Anzugsgewinde

Morse taper adaptor for tools with morse taper shank and drawbar thread

Douilles intermédiaires pour outils à cône Morse à trou fileté

Mors adaptörü çekirme civatalı



Bestell-Nr. Order Nr. Reference Sipariş Nr.	BT	Form	MK	A	D	Kg	Euro
405.08.01.50	BT 40	A	MK 1	50	25	1,04	
405.08.02.50	BT 40	A	MK 2	50	32	1,04	
405.08.03.70	BT 40	A	MK 3	70	40	1,18	
405.08.04.95	BT 40	A	MK 4	95	48	1,45	
*405.08.04A.110	BT 40	A	MK 4	110	63	2,30	
505.08.01.45	BT 50	A	MK 1	45	25	3,64	
505.08.02.60	BT 50	A	MK 2	60	32	3,68	
505.08.03.65	BT 50	A	MK 3	65	40	3,70	
505.08.04.70	BT 50	A	MK 4	70	48	3,65	
*505.08.04A.85	BT 50	A	MK 4	85	63	4,16	
505.08.05.100	BT 50	A	MK 5	100	63	3,87	
*505.08.05A.118	BT 50	A	MK 5	118	78	4,95	

* Mit Mitnahmeausfräsung nach DIN 2201

* With driving facilities to DIN 2201

* Avec douille d'accouplement de fraisure DIN 2201

* Taşıyıcı yuvalı DIN 2201

FORM A

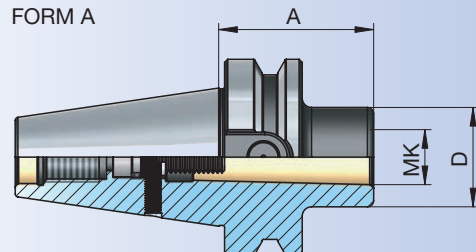

Adapter / Reduzierungen

Reduction Sleeves

Douilles de réduction

Çekirme civatalı redüksiyon

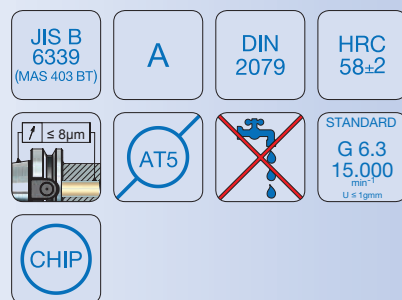

Bestell-Nr. Order Nr. Reference Sipariş Nr.	BT	Form	SK ₁	A	D	Kg	Euro
405.09.30.60	BT 40	A	SK 30	60	50	1,28	
405.09.40.100	BT 40	A	SK 40	100	63	2,20	
505.09.40.70	BT 50	A	SK 40	70	70	4,12	
505.09.50.120	BT 50	A	SK 50	120	97	6,19	

FORM A

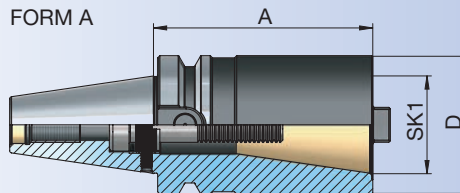

Kombi - Aufsteckfräserdorne



Combi shell mill holder

Porte-fraises á double usage pour fraises á entraînement par clavette ou tenon

Kombine malafa

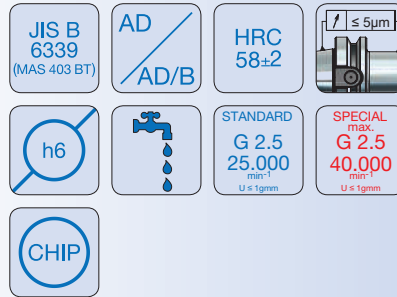

Bestell-Nr. Order Nr. Reference Sipariş Nr.	BT	Form	d	A	D	D1	L1	L3	L4	Kg	Euro
305.10.16.45	BT 30	AD	16	45	32	-	-	17	27	0,56	
305.10.22.47	BT 30	AD	22	47	40	-	-	19	31	0,70	
305.10.27.49	BT 30	AD	27	49	48	-	-	21	33	0,87	
305.10.32.52	BT 30	AD	32	52	58	-	-	24	38	1,12	
405.10.16.55	BT 40	AD	16	55	32	-	-	17	27	1,17	
406.10.16.55	BT 40	AD/B	16	55	32	-	-	17	27	1,16	
405.10.16.100	BT 40	AD	16	100	32	-	-	17	27	1,43	
406.10.16.100	BT 40	AD/B	16	100	32	-	-	17	27	1,42	
405.10.16.130	BT 40	AD	16	130	32	-	-	17	27	1,61	
406.10.16.130	BT 40	AD/B	16	130	32	-	-	17	27	1,60	
405.10.16.160	BT 40	AD	16	160	32	38	88	17	27	1,87	
406.10.16.160	BT 40	AD/B	16	160	32	38	88	17	27	1,86	
406.10.16.200	BT 40	AD/B	16	200	32	39	120	17	27	2,12	
405.10.22.55	BT 40	AD	22	55	40	-	-	19	31	1,28	
406.10.22.55	BT 40	AD/B	22	55	40	-	-	19	31	1,27	
405.10.22.100	BT 40	AD	22	100	40	-	-	19	31	1,68	
406.10.22.100	BT 40	AD/B	22	100	40	-	-	19	31	1,67	
405.10.22.130	BT 40	AD	22	130	40	-	-	19	31	1,95	
406.10.22.130	BT 40	AD/B	22	130	40	-	-	19	31	1,94	
405.10.22.160	BT 40	AD	22	160	40	46,5	88	19	31	2,33	
406.10.22.160	BT 40	AD/B	22	160	40	46,5	88	19	31	2,32	
406.10.22.200	BT 40	AD/B	22	200	40	47,5	120	19	31	2,71	

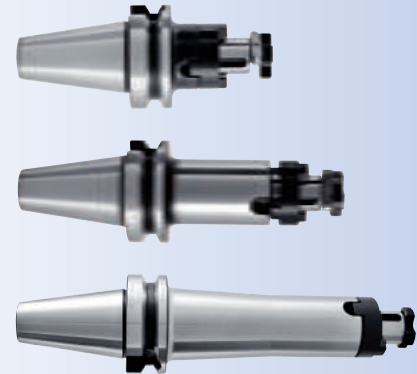
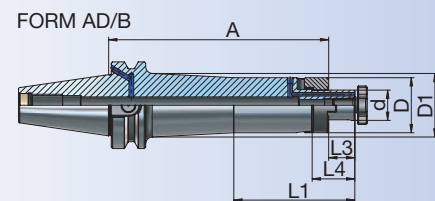
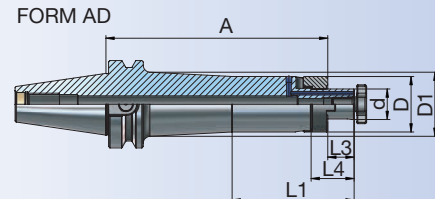

Zubehör / Accessories / Accessoires / Yedekler



Mitnehmerringe
Clutch drive rings to
Bague d'entraînement
Tırnaklı pul



Fräseranzugsschrauben
Drawn in bolt
Vis de serrage
Alın sıkma civatası



Paßfeder
Drive key
Ressort de passage
Kama



Spannschlüssel für Aufsteckdorne
Wrench
Clé de serrage
Alın civatası sıkma anahtarı

JIS B 6339
(MAS 403 BT)



Kombi - Aufsteckfräserdorne

Combi shell mill holder

Porte-fraises á double usage pour fraises á entraînement par clavette ou tenon

Kombine malafa

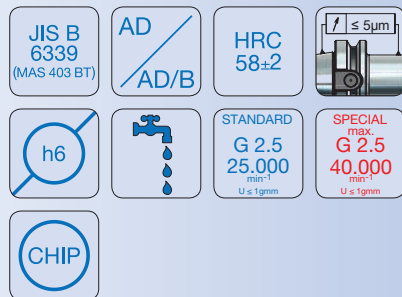

Bestell-Nr. Order Nr. Reference Sipariş Nr.	BT	Form	d	A	D	D1	L1	L3	L4	Kg	Euro
405.10.27.55	BT 40	AD	27	55	48	-	-	21	33	1,44	
406.10.27.55	BT 40	AD/B	27	55	48	-	-	21	33	1,43	
405.10.27.100	BT 40	AD	27	100	48	-	-	21	33	2,04	
406.10.27.100	BT 40	AD/B	27	100	48	-	-	21	33	2,03	
405.10.27.130	BT 40	AD	27	130	48	-	-	21	33	2,44	
406.10.27.130	BT 40	AD/B	27	130	48	-	-	21	33	2,43	
405.10.27.160	BT 40	AD	27	160	48	55	88	21	33	2,98	
406.10.27.160	BT 40	AD/B	27	160	48	55	88	21	33	2,97	
406.10.27.200	BT 40	AD/B	27	200	48	56	120	21	33	3,53	
405.10.32.60	BT 40	AD	32	60	58	-	-	24	38	1,80	
406.10.32.60	BT 40	AD/B	32	60	58	-	-	24	38	1,77	
405.10.32.100	BT 40	AD	32	100	58	-	-	24	38	2,59	
406.10.32.100	BT 40	AD/B	32	100	58	-	-	24	38	2,57	
405.10.32.130	BT 40	AD	32	130	58	-	-	24	38	3,18	
406.10.32.130	BT 40	AD/B	32	130	58	-	-	24	38	3,16	
405.10.32.160	BT 40	AD	32	160	58	-	-	24	38	3,77	
406.10.32.160	BT 40	AD/B	32	160	58	-	-	24	38	3,75	
406.10.32.200	BT 40	AD/B	32	200	58	-	-	24	38	4,54	
405.10.40.60	BT 40	AD	40	60	70	-	-	27	41	2,19	
406.10.40.60	BT 40	AD/B	40	60	70	-	-	27	41	2,16	

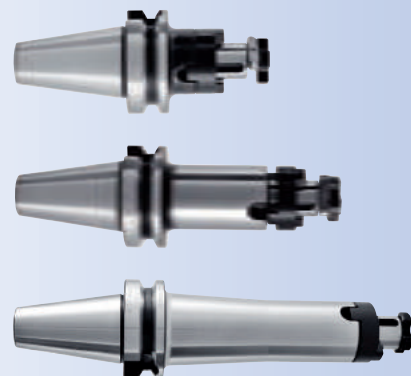
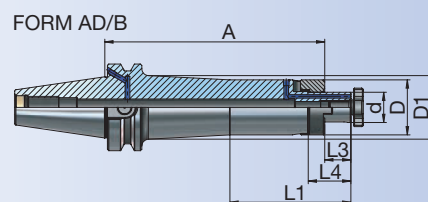
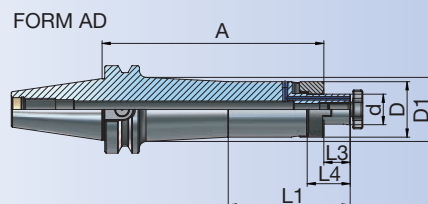

Zubehör / Accessories / Accessoires / Yedekler

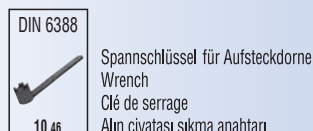

Kombi - Aufsteckfräserdorne



Combi shell mill holder

Porte-fraises á double usage pour fraises á entraînement par clavette ou tenon

Kombine malafa

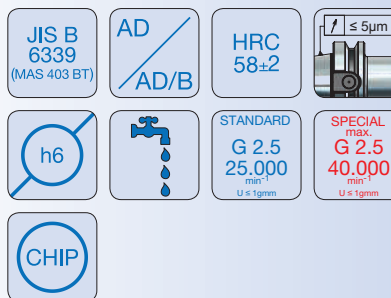

Bestell-Nr. Order Nr. Reference Sipariş Nr.	BT	Form	d	A	D	D1	L1	L3	L4	Kg	Euro
505.10.16.70	BT 50	AD	16	70	32	-	-	17	27	3,85	
506.10.16.70	BT 50	AD/B	16	70	32	-	-	17	27	3,83	
505.10.16.100	BT 50	AD	16	100	32	-	-	17	27	4,03	
506.10.16.100	BT 50	AD/B	16	100	32	-	-	17	27	4,01	
505.10.16.130	BT 50	AD	16	130	32	-	-	17	27	4,20	
506.10.16.130	BT 50	AD/B	16	130	32	-	-	17	27	4,18	
505.10.16.160	BT 50	AD	16	160	32	37	88	17	27	4,43	
506.10.16.160	BT 50	AD/B	16	160	32	37	88	17	27	4,42	
506.10.16.200	BT 50	AD/B	16	200	32	38	120	17	27	4,67	
505.10.22.70	BT 50	AD	22	70	40	-	-	19	31	3,97	
506.10.22.70	BT 50	AD/B	22	70	40	-	-	19	31	3,95	
505.10.22.100	BT 50	AD	22	100	40	-	-	19	31	4,23	
506.10.22.100	BT 50	AD/B	22	100	40	-	-	19	31	4,22	
505.10.22.130	BT 50	AD	22	130	40	-	-	19	31	4,50	
506.10.22.130	BT 50	AD/B	22	130	40	-	-	19	31	4,48	
505.10.22.160	BT 50	AD	22	160	40	45,5	88	19	31	4,84	
506.10.22.160	BT 50	AD/B	22	160	40	45,5	88	19	31	4,83	
506.10.22.200	BT 50	AD/B	22	200	40	46	120	19	31	5,21	
505.10.27.70	BT 50	AD	27	70	48	-	-	21	33	4,15	
506.10.27.70	BT 50	AD/B	27	70	48	-	-	21	33	4,13	
505.10.27.100	BT 50	AD	27	100	48	-	-	21	33	4,55	
506.10.27.100	BT 50	AD/B	27	100	48	-	-	21	33	4,52	
505.10.27.130	BT 50	AD	27	130	48	-	-	21	33	4,95	
506.10.27.130	BT 50	AD/B	27	130	48	-	-	21	33	4,92	
505.10.27.160	BT 50	AD	27	160	48	53,5	88	21	33	5,44	
506.10.27.160	BT 50	AD/B	27	160	48	53,5	88	21	33	5,41	
506.10.27.200	BT 50	AD/B	27	200	48	54,5	120	21	33	5,97	

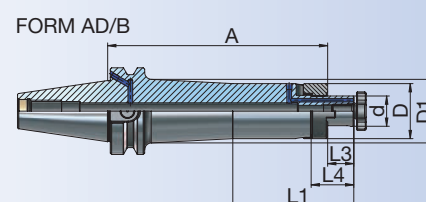
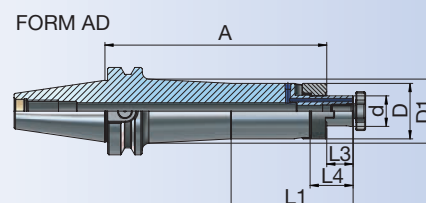

Zubehör / Accessories / Accessoires / Yedekler



Mitnehmerringe
Clutch drive rings to
Bague d'entraînement
Tırnaklı pul



Fräseranzugsschrauben
Drawn in bolt
Vis de serrage
Alın sıkma civatası



Paßfeder
Drive key
Ressort de passage
Kama



Spannschlüssel für Aufsteckdorne
Wrench
Clé de serrage
Alın civatası sıkma anahtarı

JIS B 6339
(MAS 403 BT)



Kombi - Aufsteckfräserdorne

Combi shell mill holder

Porte-fraises á double usage pour fraises á entraînement par clavette ou tenon

Kombine malafa

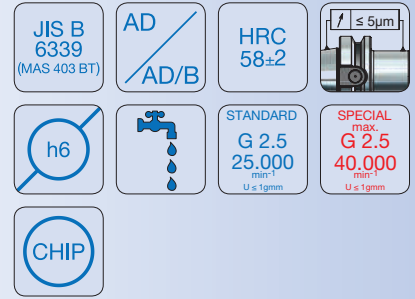

Bestell-Nr. Order Nr. Reference Sipariş Nr.	BT	Form	d	A	D	D1	L1	L3	L4	Kg	Euro
505.10.32.70	BT 50	AD	32	70	58	-	-	24	38	4,43	
506.10.32.70	BT 50	AD/B	32	70	58	-	-	24	38	4,39	
505.10.32.100	BT 50	AD	32	100	58	-	-	24	38	5,03	
506.10.32.100	BT 50	AD/B	32	100	58	-	-	24	38	4,99	
505.10.32.130	BT 50	AD	32	130	58	-	-	24	38	5,62	
506.10.32.130	BT 50	AD/B	32	130	58	-	-	24	38	5,58	
505.10.32.160	BT 50	AD	32	160	58	64	88	24	38	6,34	
506.10.32.160	BT 50	AD/B	32	160	58	64	88	24	38	6,30	
506.10.32.200	BT 50	AD/B	32	200	58	64,5	120	24	38	7,13	
505.10.40.70	BT 50	AD	40	70	70	-	-	27	41	4,88	
506.10.40.70	BT 50	AD/B	40	70	70	-	-	27	41	4,83	
505.10.40.100	BT 50	AD	40	100	70	-	-	27	41	5,76	
506.10.40.100	BT 50	AD/B	40	100	70	-	-	27	41	5,72	
505.10.40.130	BT 50	AD	40	130	70	-	-	27	41	6,64	
506.10.40.130	BT 50	AD/B	40	130	70	-	-	27	41	6,59	
505.10.40.160	BT 50	AD	40	160	70	76	88	27	41	7,68	
506.10.40.160	BT 50	AD/B	40	160	70	76	88	27	41	7,64	
506.10.40.200	BT 50	AD/B	40	200	70	77	120	27	41	8,85	

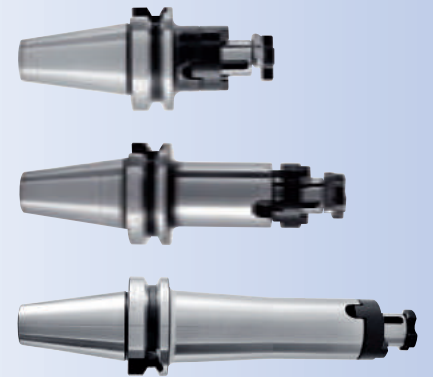
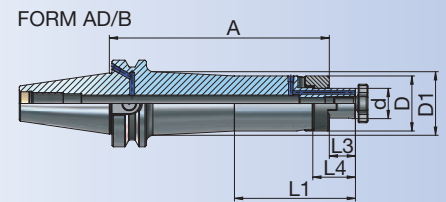
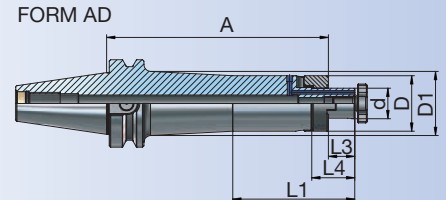

Zubehör / Accessories / Accessoires / Yedekler

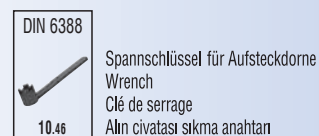
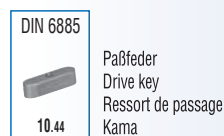

Quernut-Aufsteckdorne mit vergrößertem Bunddurchmesser

Shell mill holder for cutters with driving slot

Porte-fraises à surfacer avec diamètre de collerette élargi

Alın kamalı malafa

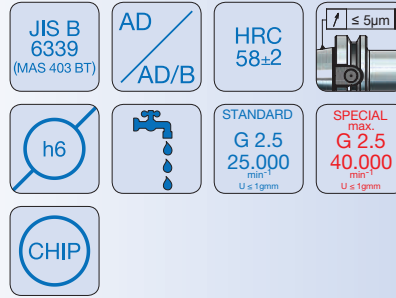

Bestell-Nr. Order Nr. Reference Sipariş Nr.	BT	Form	d	A	D	D1	L1	L3	Kg	Euro
305.11.16.40	BT 30	AD	16	40	38	-	-	17	0,58	
305.11.22.40	BT 30	AD	22	40	48	-	-	19	0,70	
305.11.27.50	BT 30	AD	27	50	60	-	-	21	1,06	
305.11.32.50	BT 30	AD	32	50	78	-	-	24	1,46	
405.11.16.40	BT 40	AD	16	40	38	-	-	17	1,14	
406.11.16.40	BT 40	AD/B	16	40	38	-	-	17	1,11	
405.11.16.100	BT 40	AD	16	100	38	-	-	17	1,67	
406.11.16.100	BT 40	AD/B	16	100	38	-	-	17	1,62	
405.11.16.130	BT 40	AD	16	130	38	-	-	17	1,96	
406.11.16.130	BT 40	AD/B	16	130	38	-	-	17	1,89	
405.11.16.160	BT 40	AD	16	160	38	44	88	17	2,30	
406.11.16.160	BT 40	AD/B	16	160	38	44	88	17	2,22	
405.11.16.200	BT 40	AD	16	200	38	45	120	17	2,69	
new 406.11.16.200	BT 40	AD/B	16	200	38	45	120	17	2,68	
405.11.22.40	BT 40	AD	22	40	48	-	-	19	1,25	
406.11.22.40	BT 40	AD/B	22	40	48	-	-	19	1,21	
405.11.22.100	BT 40	AD	22	100	48	-	-	19	2,10	
406.11.22.100	BT 40	AD/B	22	100	48	-	-	19	2,00	
405.11.22.130	BT 40	AD	22	130	48	-	-	19	2,52	
406.11.22.130	BT 40	AD/B	22	130	48	-	-	19	2,40	
405.11.22.160	BT 40	AD	22	160	48	54,5	88	19	3,07	
406.11.22.160	BT 40	AD/B	22	160	48	54,5	88	19	2,92	
405.11.22.200	BT 40	AD	22	200	48	55,5	120	19	3,67	
new 406.11.22.200	BT 40	AD/B	22	200	48	55,5	120	19	3,66	

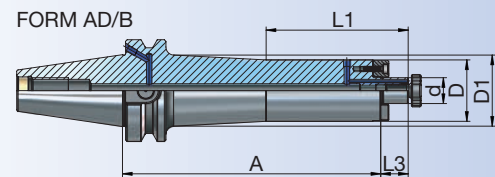
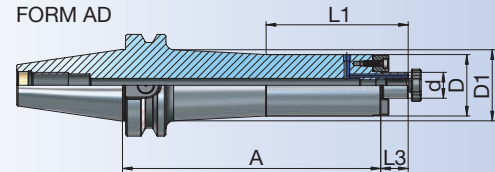

Zubehör / Accessories / Accessoires / Yedekler

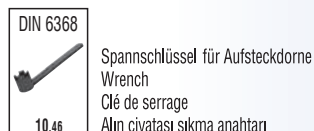



Quernut-Aufsteckdorne mit vergrößertem Bunddurchmesser

Shell mill holder for cutters with driving slot

Porte-fraises à surfacier avec diamètre de collerette élargi

Alın kamalı malafa

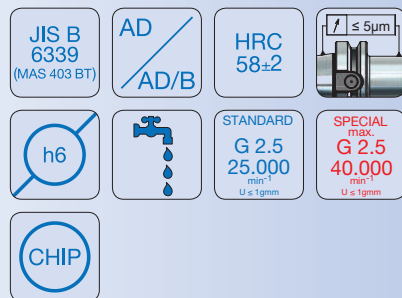

Bestell-Nr. Order Nr. Reference Sipariş Nr.	BT	Form	d	A	D	D1	L1	L3	Kg	Euro
405.11.27.40	BT 40	AD	27	40	60	-	-	21	1,41	
406.11.27.40	BT 40	AD/B	27	40	60	-	-	21	1,36	
405.11.27.100	BT 40	AD	27	100	60	-	-	21	2,73	
406.11.27.100	BT 40	AD/B	27	100	60	-	-	21	2,63	
405.11.27.130	BT 40	AD	27	130	60	-	-	21	3,39	
406.11.27.130	BT 40	AD/B	27	130	60	-	-	21	3,27	
405.11.27.160	BT 40	AD	27	160	60	-	-	21	4,05	
406.11.27.160	BT 40	AD/B	27	160	60	-	-	21	3,90	
405.11.27.200	BT 40	AD	27	200	60	-	-	21	4,94	
new 406.11.27.200	BT 40	AD/B	27	200	60	-	-	21	4,93	
405.11.32.50	BT 40	AD	32	50	78	-	-	24	1,93	
406.11.32.50	BT 40	AD/B	32	50	78	-	-	24	1,87	
405.11.32.100	BT 40	AD	32	100	78	-	-	24	3,79	
406.11.32.100	BT 40	AD/B	32	100	78	-	-	24	3,68	
405.11.32.130	BT 40	AD	32	130	78	-	-	24	4,90	
406.11.32.130	BT 40	AD/B	32	130	78	-	-	24	4,77	
405.11.32.160	BT 40	AD	32	160	78	-	-	24	6,02	
406.11.32.160	BT 40	AD/B	32	160	78	-	-	24	5,86	
405.11.32.200	BT 40	AD	32	200	78	-	-	24	7,51	
new 406.11.32.200	BT 40	AD/B	32	200	78	-	-	24	7,50	
*405.11.40.50	BT 40	AD	40	50	88	-	-	27	2,13	
*406.11.40.50	BT 40	AD/B	40	50	88	-	-	27	2,07	

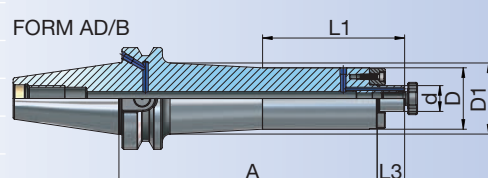
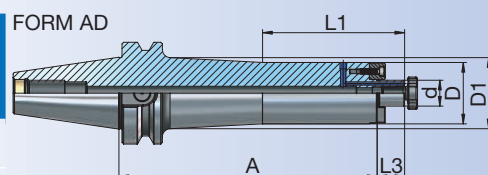

* d=Ø 40 (M12)

Mit zusätzlichen 4 Gewindebohrungen nach DIN 2079
With additional 4 screws holes in compliance with DIN 2079
Avec 4 trous taraudés supplémentaires d'après DIN 2079
DIN 2079 'a uygun ilave 4 vida bağlantılı

Zubehör / Accessories / Accessoires / Yedekler



Fräseranzugsschrauben
Drawn in bolt
Vis de serrage
Alın sıkma civatası



Mitnehmersteine
Drive keys
Entraîneur
Kama



Spannschlüssel für Aufsteckdorne
Wrench
Clé de serrage
Alın civatası sıkma anahtarı

Quernut-Aufsteckdorne mit vergrößertem Bunddurchmesser



Shell mill holder for cutters with driving slot

Porte-fraises à surfacer avec diamètre de collerette élargi

Alın kamalı malafa

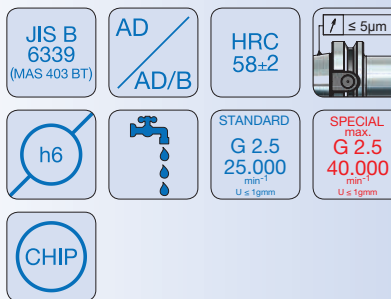

Bestell-Nr. Order Nr. Reference Sipariş Nr.	BT	Form	d	A	D	D1	L1	L3	Kg	Euro
505.11.16.50	BT 50	AD	16	50	38	-	-	17	3,80	
506.11.16.50	BT 50	AD/B	16	50	38	-	-	17	3,75	
505.11.16.100	BT 50	AD	16	100	38	-	-	17	4,25	
506.11.16.100	BT 50	AD/B	16	100	38	-	-	17	4,17	
505.11.16.130	BT 50	AD	16	130	38	-	-	17	4,53	
506.11.16.130	BT 50	AD/B	16	130	38	-	-	17	4,44	
505.11.16.160	BT 50	AD	16	160	38	42,5	88	17	4,86	
506.11.16.160	BT 50	AD/B	16	160	38	42,5	88	17	4,76	
505.11.16.200	BT 50	AD	16	200	38	43	120	17	5,27	
new 506.11.16.200	BT 50	AD/B	16	200	38	43	120	17	5,26	
505.11.22.55	BT 50	AD	22	55	48	-	-	19	3,98	
506.11.22.55	BT 50	AD/B	22	55	48	-	-	19	3,90	
505.11.22.100	BT 50	AD	22	100	48	-	-	19	4,61	
506.11.22.100	BT 50	AD/B	22	100	48	-	-	19	4,49	
505.11.22.130	BT 50	AD	22	130	48	-	-	19	5,06	
506.11.22.130	BT 50	AD/B	22	130	48	-	-	19	4,91	
505.11.22.160	BT 50	AD	22	160	48	53	88	19	5,57	
506.11.22.160	BT 50	AD/B	22	160	48	53	88	19	5,39	
505.11.22.200	BT 50	AD	22	200	48	53	120	19	6,20	
new 506.11.22.200	BT 50	AD/B	22	200	48	53	120	19	6,19	
505.11.27.55	BT 50	AD	27	55	60	-	-	21	4,17	
506.11.27.55	BT 50	AD/B	27	55	60	-	-	21	4,09	
505.11.27.100	BT 50	AD	27	100	60	-	-	21	5,17	
506.11.27.100	BT 50	AD/B	27	100	60	-	-	21	5,04	
505.11.27.130	BT 50	AD	27	130	60	-	-	21	5,85	
506.11.27.130	BT 50	AD/B	27	130	60	-	-	21	5,70	
505.11.27.160	BT 50	AD	27	160	60	65	88	21	6,63	
506.11.27.160	BT 50	AD/B	27	160	60	65	88	21	6,45	
505.11.27.200	BT 50	AD	27	200	60	65,5	120	21	7,60	
new 506.11.27.200	BT 50	AD/B	27	200	60	65,5	120	21	7,59	

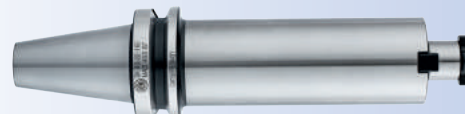
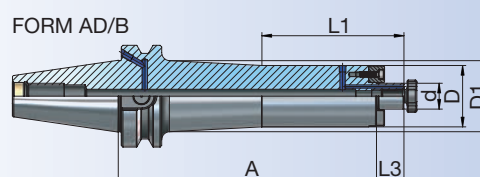
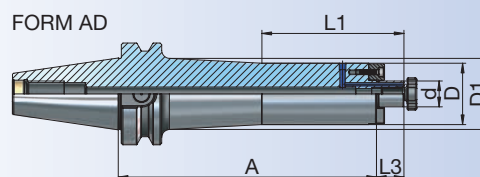

Zubehör / Accessories / Accessoires / Yedekler

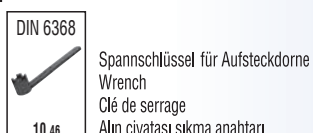



Quernut-Aufsteckdorne mit vergrößertem Bunddurchmesser

Shell mill holder for cutters with driving slot

Porte-fraises à surfacer avec diamètre de collerette élargi

Alın kamalı malafa

JIS B
6339
(MAS 403 BT)

AD
AD/B

HRC
58±2



h6



STANDARD
G 2.5
25.000
min⁻¹
U ≤ 1gmm

SPECIAL
max.
G 2.5
40.000
min⁻¹
U ≤ 1gmm

CHIP

Bestell-Nr. Order Nr. Reference Sipariş Nr.	BT	Form	d	A	D	D1	L1	L3	Kg	Euro
505.11.32.55	BT 50	AD	32	55	78	-	-	24	4,52	
506.11.32.55	BT 50	AD/B	32	55	78	-	-	24	4,44	
505.11.32.100	BT 50	AD	32	100	78	-	-	24	6,20	
506.11.32.100	BT 50	AD/B	32	100	78	-	-	24	6,07	
505.11.32.130	BT 50	AD	32	130	78	-	-	24	7,32	
506.11.32.130	BT 50	AD/B	32	130	78	-	-	24	7,16	
505.11.32.160	BT 50	AD	32	160	78	84	88	24	8,61	
506.11.32.160	BT 50	AD/B	32	160	78	84	88	24	8,42	
505.11.32.200	BT 50	AD	32	200	78	84,5	120	24	10,15	
new 506.11.32.200	BT 50	AD/B	32	200	78	84,5	120	24	10,14	
*505.11.40.55	BT 50	AD	40	55	88	-	-	27	4,78	
*506.11.40.55	BT 50	AD/B	40	55	88	-	-	27	4,68	
*505.11.40.100	BT 50	AD	40	100	88	-	-	27	6,91	
*506.11.40.100	BT 50	AD/B	40	100	88	-	-	27	6,77	
*505.11.40.130	BT 50	AD	40	130	88	-	-	27	8,33	
*506.11.40.130	BT 50	AD/B	40	130	88	-	-	27	8,17	
*505.11.40.160	BT 50	AD	40	160	88	94,5	88	27	9,97	
*506.11.40.160	BT 50	AD/B	40	160	88	94,5	88	27	9,78	
*505.11.40.200	BT 50	AD	40	200	88	95,5	120	27	11,93	
new *506.11.40.200	BT 50	AD/B	40	200	88	95,5	120	27	11,92	
*505.11.60.80	BT 50	AD	60	80	128	-	-	40	8,02	
*506.11.60.80	BT 50	AD/B	60	80	128	-	-	40	7,89	

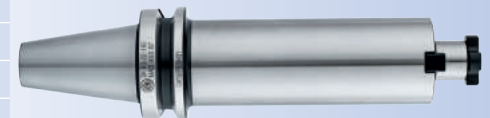
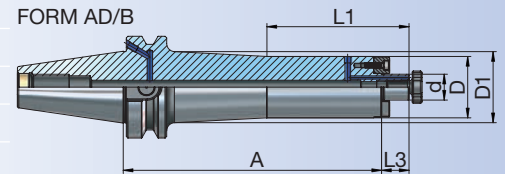
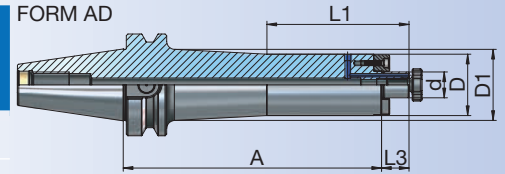

* d=Ø 40 (M12) * d=Ø 60 (M16)

Mit zusätzlichen 4 Gewindebohrungen nach DIN 2079
With additional 4 screws holes in compliance with DIN 2079
Avec 4 trous taraudés supplémentaires d'après DIN 2079
DIN 2079 'a uygun ilave 4 vida bağlantılı

Zubehör / Accessories / Accessoires / Yedekler



DIN 6367
Fräseranzugsschrauben
Drawn in bolt
Vis de serrage
Alın sıkma civatası



DIN 6368
Mitnehmersteine
Drive keys
Entraîneur
Kama



DIN 6368
Spannschlüssel für Aufsteckdorne
Wrench
Clé de serrage
Alın civatası sıkma anahtarı

Fräseraufnahmen für Einschraubfräser

Milling Cutter Arbors for Screw-on type Milling Cutters

Axes Coupeur Fraisage Pour Vis-Sur Type Coupeurs de Fraisage

Vidalı tip frezeler için takım tutucular



JIS B
6339
(MAS 403 BT)

AD/B

HRC
58±2



H5



STANDARD
G 2.5
min⁻¹
U ≤ 1gmm

SPECIAL
max.
G 2.5
40.000
min⁻¹
U ≤ 1gmm

CHIP

JIS B 6339
(MAS 403 BT)

Bestell-Nr. Order Nr. Reference Sipariş Nr.	BT	Form	M	A	d	D	D1	Kg	Euro
406.12.06.52	BT 40	AD/B	M6	52	6,5	10	13	0,96	
406.12.06.77	BT 40	AD/B	M6	77	6,5	10	19,5	1,00	
406.12.06.102	BT 40	AD/B	M6	102	6,5	10	22,5	1,05	
406.12.08.52	BT 40	AD/B	M8	52	8,5	13	15	0,96	
406.12.08.77	BT 40	AD/B	M8	77	8,5	13	22,5	1,02	
406.12.08.102	BT 40	AD/B	M8	102	8,5	13	23	1,07	
406.12.08.127	BT 40	AD/B	M8	127	8,5	13	25	1,14	
406.12.10.32	BT 40	AD/B	M10	32	10,5	18	-	0,97	
406.12.10.52	BT 40	AD/B	M10	52	10,5	18	20	0,98	
406.12.10.77	BT 40	AD/B	M10	77	10,5	18	23	1,05	
406.12.10.102	BT 40	AD/B	M10	102	10,5	18	28	1,16	
406.12.10.127	BT 40	AD/B	M10	127	10,5	18	32	1,29	
406.12.10.177	BT 40	AD/B	M10	177	10,5	18	36	1,60	
406.12.12.32	BT 40	AD/B	M12	32	12,5	21	-	0,96	
406.12.12.52	BT 40	AD/B	M12	52	12,5	21	24	1,00	
406.12.12.77	BT 40	AD/B	M12	77	12,5	21	24	1,06	
406.12.12.102	BT 40	AD/B	M12	102	12,5	21	31	1,21	
406.12.12.127	BT 40	AD/B	M12	127	12,5	21	32,5	1,35	
406.12.12.152	BT 40	AD/B	M12	152	12,5	21	35,5	1,52	
406.12.12.177	BT 40	AD/B	M12	177	12,5	21	39,5	1,76	
406.12.16.32	BT 40	AD/B	M16	32	17	29	-	0,94	
406.12.16.52	BT 40	AD/B	M16	52	17	29	-	1,03	
406.12.16.77	BT 40	AD/B	M16	77	17	29	34	1,18	
406.12.16.102	BT 40	AD/B	M16	102	17	29	34	1,33	
406.12.16.127	BT 40	AD/B	M16	127	17	29	36	1,52	
406.12.16.152	BT 40	AD/B	M16	152	17	29	40	1,78	
406.12.16.177	BT 40	AD/B	M16	177	17	29	42,5	2,04	

FORM AD/B

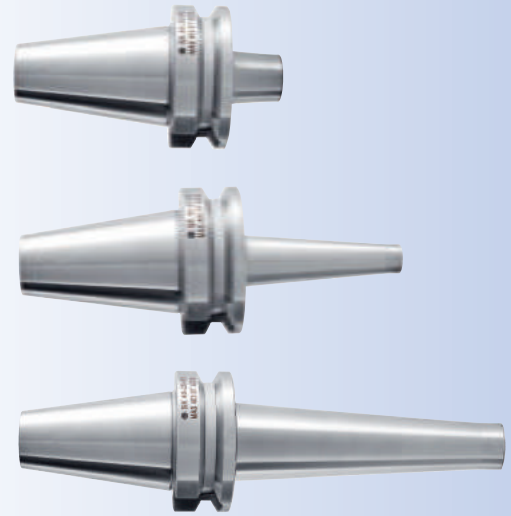
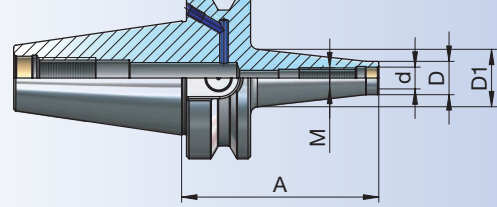

Empfohlene Anzugsmomente
Recommended tightening torques
Torques de serrage recommandés
Önerilen sıkma torqu

M6	10 Nm
M8	25 Nm
M10	40 Nm
M12	60 Nm
M16	80 Nm

Zubehör / Accessories / Accessoires / Yedekler



Verlängerungen für Einschraubfräser
Extensions for milling cutter arbors
Extension pour vis-sur-type coupeurs de fraisage
Vidalı tip frezeler için ara adaptör



Reduzierungen für Einschraubfräser
Reducing for milling cutter arbors
Extension pour vis-sur-type coupeurs de fraisage
Vidalı tip frezeler için ara adaptör



Fräseraufnahmen für Einschraubfräser

Milling Cutter Arbors for Screw-on type Milling Cutters

Axes Coupeur Fraisage Pour Vis-Sur Type Coupeurs de Fraisage

Vidalı tip frezeler için takım tutucular

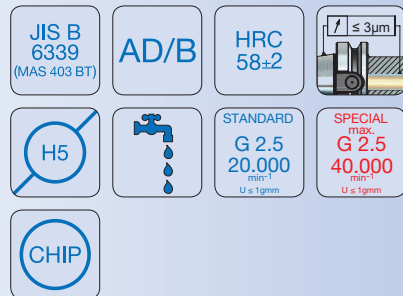

Bestell-Nr. Order Nr. Reference Sipariş Nr.	BT	Form	M	A	d	D	D1	Kg	Euro
506.12.08.88	BT 50	AD/B	M8	88	8,5	13	22,5	3,66	
506.12.08.138	BT 50	AD/B	M8	138	8,5	13	24,5	3,78	
506.12.08.188	BT 50	AD/B	M8	188	8,5	13	29,5	3,97	
506.12.10.88	BT 50	AD/B	M10	88	10,5	18	23	3,68	
506.12.10.138	BT 50	AD/B	M10	138	10,5	18	31,5	3,92	
506.12.10.188	BT 50	AD/B	M10	188	10,5	18	36	4,15	
506.12.12.88	BT 50	AD/B	M12	88	12,5	21	24	3,70	
506.12.12.138	BT 50	AD/B	M12	138	12,5	21	32,5	3,97	
506.12.12.188	BT 50	AD/B	M12	188	12,5	21	39,5	4,38	
506.12.16.88	BT 50	AD/B	M16	88	17	29	34	3,82	
506.12.16.138	BT 50	AD/B	M16	138	17	29	36	4,15	
506.12.16.188	BT 50	AD/B	M16	188	17	29	42	4,66	

FORM AD/B

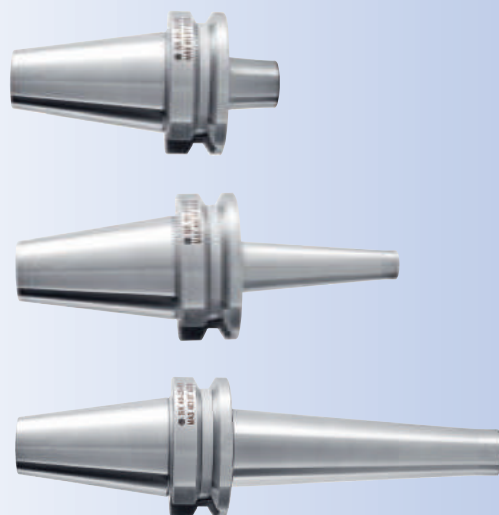
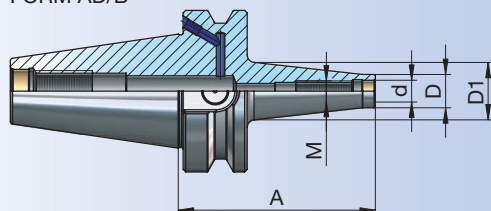

Empfohlene Anzugsmomente Recommended tightening torques Torques de serrage recommandés Önerilen sıkma torku

M6	10 Nm
M8	25 Nm
M10	40 Nm
M12	60 Nm
M16	80 Nm

Zubehör / Accessories / Accessoires / Yedekler



Verlängerungen für Einschraubfräser
Extensions for milling cutter arbors
Extension pour vis-sur-type coupeurs de fraisage
Vidalı tip frezeler için ara adaptör



Reduzierungen für Einschraubfräser
Reducing for milling cutter arbors
Extension pour vis-sur-type coupeurs de fraisage
Vidalı tip frezeler için ara adaptör

Fräseraufnahmen für Einschraubfräser, schlanke Ausführung



Milling Cutter Arbors for Screw-on type Milling Cutters,
slimline design

Axes Coupeur Fraisage Pour Vis-Sur Type Coupeurs de Fraisage,
design mince

Vidalı tip frezeler için takım tutucular, ince cidarlı

JIS B
6339
(MAS 403 BT)

AD/B

HRC
58±2

≤ 3µm

H5



STANDARD
G 2.5
20,000
max
U ≤ 1µm

SPECIAL
max
G 2.5
40,000
max
U ≤ 1µm

CHIP

Bestell-Nr. Order Nr. Reference Sipariş Nr.	BT	Form	M	A	d	D	L	Kg	Euro
406.12.10.102.S	BT 40	AD/B	M10	102	10,5	18	75	1,07	
406.12.10.127.S	BT 40	AD/B	M10	127	10,5	18	100	1,11	
406.12.10.177.S	BT 40	AD/B	M10	177	10,5	18	150	1,21	
406.12.12.102.S	BT 40	AD/B	M12	102	12,5	21	75	1,11	
406.12.12.127.S	BT 40	AD/B	M12	127	12,5	21	100	1,17	
406.12.12.152.S	BT 40	AD/B	M12	152	12,5	21	125	1,24	
406.12.12.177.S	BT 40	AD/B	M12	177	12,5	21	150	1,31	
406.12.16.102.S	BT 40	AD/B	M16	102	17	29	75	1,27	
406.12.16.127.S	BT 40	AD/B	M16	127	17	29	100	1,39	
406.12.16.152.S	BT 40	AD/B	M16	152	17	29	125	1,52	
406.12.16.177.S	BT 40	AD/B	M16	177	17	29	150	1,64	

FORM AD/B

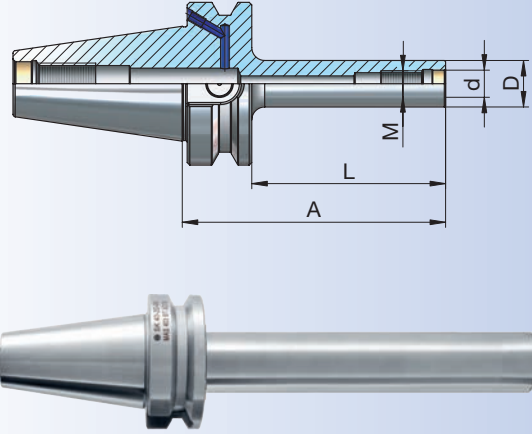

506.12.10.138.S	BT 50	AD/B	M10	138	10,5	18	100	3,76	
506.12.10.188.S	BT 50	AD/B	M10	188	10,5	18	150	3,84	
506.12.12.138.S	BT 50	AD/B	M12	138	12,5	21	100	3,82	
506.12.12.188.S	BT 50	AD/B	M12	188	12,5	21	150	3,94	
506.12.16.138.S	BT 50	AD/B	M16	138	17	29	100	4,04	
506.12.16.188.S	BT 50	AD/B	M16	188	17	29	150	4,29	

Empfohlene Anzugsmomente
Recommended tightening torques
Torques de serrage recommandés
Önerilen sıkma torku

M6	10 Nm
M8	25 Nm
M10	40 Nm
M12	60 Nm
M16	80 Nm

Zubehör / Accessories / Accessoires / Yedekler



Verlängerungen für Einschraubfräser
Extensions for milling cutter arbors
Extension pour - sur - type coupeurs de fraisage
Vidalı tip frezeler için ara adaptör



Reduzierungen für Einschraubfräser
Reducing for milling cutter arbors
Extension pour vis - sur - type coupeurs de fraisage
Vidalı tip frezeler için ara adaptör

JIS B 6339
(MAS 403 BT)



Bohrerhalter für Wendepplattenbohrer E1

Boring holder for drill with indexable insert form E1

Porte foret pour foret à plaquettes réversible forme E1

Takma uçlu drill tutucu E1 Formu

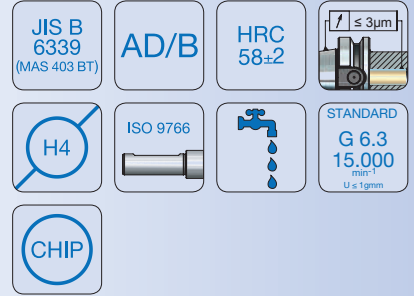

Bestell-Nr. Order Nr. Reference Sipariş Nr.	BT	Form	d	A	D	L2	Kg	Euro
406.51.20.72	BT 40	AD/B	20	72	40	54	1,24	
406.51.25.76	BT 40	AD/B	25	76	45	62	1,31	
•406.51.32.80	BT 40	AD/B	32	80	52	67	1,38	
406.51.40.100	BT 40	AD/B	40	100	63	73	1,78	
506.51.20.90	BT 50	AD/B	20	90	40	54	3,80	
506.51.25.90	BT 50	AD/B	25	90	45	59	3,85	
506.51.32.90	BT 50	AD/B	32	90	52	70	3,91	
506.51.40.100	BT 50	AD/B	40	100	63	80	4,04	

FORM AD/B

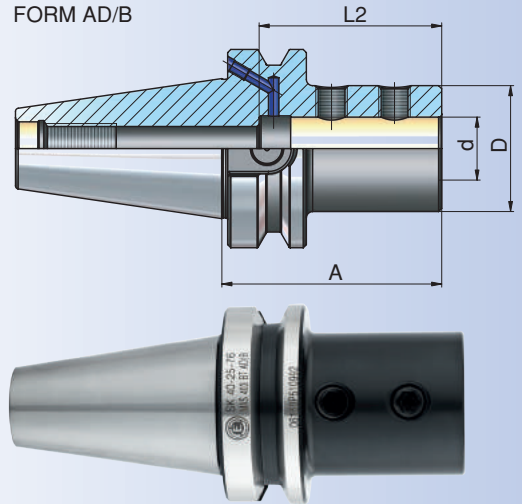

- Technisch gibt es keinen Chip.
- Technically there is no chip hole.
- Techniquement, il n'y a pas de puce.
- Teknik açıdan çip deliği bulunmamaktadır.

Zubehör / Accessories / Accessoires / Yedekler



Bohrfutteraufnahme

Drill chuck adaptor

Arbre pour mandrin de perçage

Mandren malafası



Bestell-Nr. Order Nr. Reference Sipariş Nr.	BT	Form	D1	A	L1	Kg	Euro
305.14.12.27	BT 30	A	B12	27	18,5	0,41	
305.14.16.29	BT 30	A	B16	29	24	0,43	
405.14.12.32	BT 40	A	B12	32	18,5	1,00	
405.14.16.34	BT 40	A	B16	34	24	1,03	
405.14.18.34	BT 40	A	B18	34	32	1,05	
505.14.16.45	BT 50	A	B16	45	24	3,70	
505.14.18.45	BT 50	A	B18	45	32	3,72	

FORM A

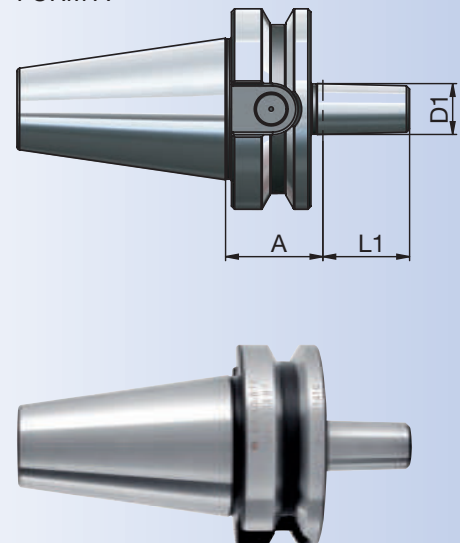

Zubehör / Accessories / Accessoires / Yedekler



NC - Bohrfutter für Rechts - und Linkslauf

NC-Drill chucks for left and right rotation

Mandrin de perçage CNC pour rotation gauche-droite

NC tipi mandren malafası komple sağ ve sol dönüşlü

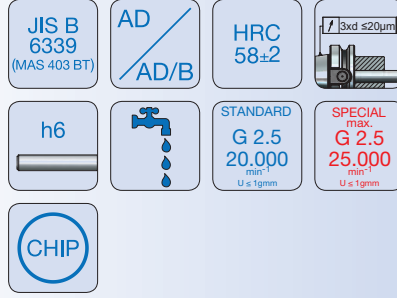

JIS B 6339
(MAS 403 BT)

Bestell-Nr. Order Nr. Reference Sipariş Nr.	BT	Form	Spannbereich Capacity Capacité Kapasite	A		A1 Max.	Kg	Euro
				A	D			
305.15.08.73	BT 30	AD	0,5 - 8	73	36	76	0,70	
305.15.13.100	BT 30	AD	1,0 - 13	100	50	108	1,29	
405.15.08.78	BT 40	AD	0,5 - 8	78	36	81	1,30	
406.15.08.78	BT 40	AD/B	0,5 - 8	78	36	81	1,27	
405.15.13.98	BT 40	AD	1,0 - 13	98	50	116	1,83	
406.15.13.98	BT 40	AD/B	1,0 - 13	98	50	116	1,76	
405.15.16.103	BT 40	AD	3,0 - 16	103	57	108	2,05	
406.15.16.103	BT 40	AD/B	3,0 - 16	103	57	108	2,00	
505.15.13.110	BT 50	AD	1,0 - 13	110	50	118	4,61	
506.15.13.110	BT 50	AD/B	1,0 - 13	110	50	118	4,51	
505.15.16.115	BT 50	AD	3,0 - 16	115	57	120	4,93	
506.15.16.115	BT 50	AD/B	3,0 - 16	115	57	120	4,75	

FORM AD

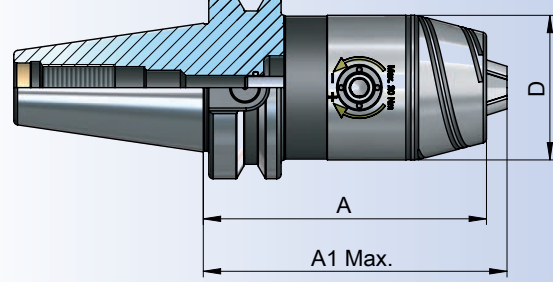

FORM AD/B

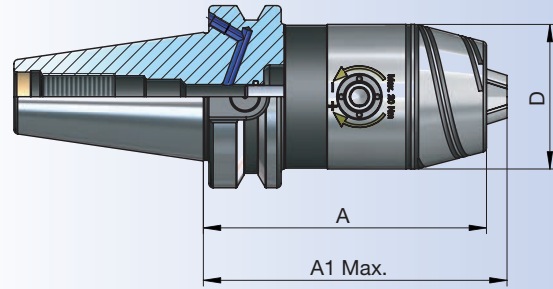

Zubehör / Accessories / Accessoires / Yedekler

	Ersatzteile Spare Parts Pièce de rechange Yedek parçalar		Spannschlüssel Wrench Clé de serrage Sıkma anahtarı	
10.55-10.57		10.49		11.06



Gewindeschneid - Schnellwechselfutter mit Längenausgleich auf Druck und Zug

Quick-change tapping chucks with length compensation

Appareil à tarauder avec compensation longitudinale

Kılavuz çekme başlığı giriş ve çıkış kompanzeli

JIS B
6339
(MAS 403 BT)

A

HRC
58±2



Bestell-Nr. Order Nr. Reference Sipariş Nr.	BT	Form	Spannbereich Capacity Capacité Kapasite	d	A	D	C	T	Kg	Euro
305.16.12.64	BT 30	A	M2-M14	19	64	36,5	7	7	0,58	
305.16.20.95	BT 30	A	M5-M24	31	95	53,5	12	12	1,17	
405.16.12.67	BT 40	A	M2-M14	19	67	36,5	7	7	1,14	
405.16.20.93	BT 40	A	M5-M24	31	93	53,5	12	12	1,65	
405.16.36.136	BT 40	A	M14-M36	48	136	78	20	20	3,23	
505.16.12.82	BT 50	A	M2-M14	19	82	36,5	7	7	3,69	
505.16.20.100	BT 50	A	M5-M24	31	100	53,5	12	12	4,14	
505.16.36.142	BT 50	A	M14-M36	48	142	78	17,5	17,5	5,72	

FORM A

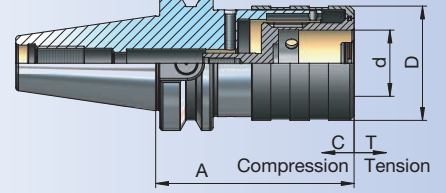

Ausführung : Mit Kugelführungsbuchse

Version : With ball retainer

Version : Comprenant douille de glissière à bille

Teknik özelliği : Bilya Kafesi

Gewindeschneid - Schnellwechselfutter ohne Längenausgleich auf Druck und Zug

Quick-change tapping chucks without length compensation

Appareil à tarauder sans compensation longitudinale

Kılavuz çekme başlığı sabit

JIS B
6339
(MAS 403 BT)

A

HRC
58±2



Bestell-Nr. Order Nr. Reference Sipariş Nr.	BT	Form	Spannbereich Capacity Capacité Kapasite	d	A	D	Kg	Euro
305.16.12.1.65	BT 30	A	M2-M14	19	65	38	0,60	
305.16.20.1.80	BT 30	A	M5-M24	31	80	52	0,96	
405.16.12.1.67	BT 40	A	M2-M14	19	67,5	38	1,24	
405.16.20.1.93	BT 40	A	M5-M24	31	93	52	1,59	
405.16.36.1.126	BT 40	A	M14-M36	48	126	78	3,23	
505.16.12.1.80	BT 50	A	M2-M14	19	80	38	4,00	
505.16.20.1.100	BT 50	A	M5-M24	31	100	52	4,11	
505.16.36.1.142	BT 50	A	M14-M36	48	142	78	5,93	

FORM A

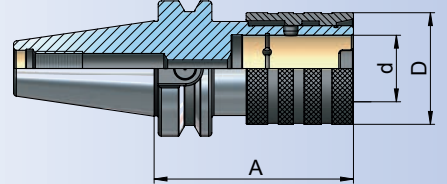

Zubehör / Accessories / Accessoires / Yedekler



Schnellwechseleinsätze
Tapping collets
Douilles de taraudage
Kılavuz tutucu



Rohlinge zur Anfertigung von Sonderwerkzeugen

Boring bar blanks for the production of special tools

Barre d'alésage pour la fabrication d'outils spéciaux

Özel takım yapma amaçlı yarı mamul

JIS B
6339
(MAS 403 BT)

A

HRC
52±2



CHIP

Bestell-Nr. Order Nr. Reference Sipariş Nr.	BT	Form	D	A	Kg	Euro
405.17.63.250	BT 40	A	63	250	6,38	
505.17.97.315	BT 50	A	97	315	19,61	

FORM A

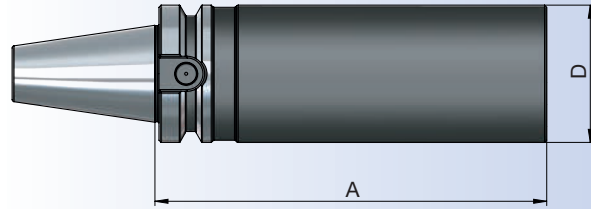

Ausführung : Steilkegel und Bund gehärtet (52 ± 2 HRC) und geschliffen, Schaft weich zur weiteren Bearbeitung.

Version : Cone and flange hardened (52 ± 2 HRC) and grinded. Soft body for later processing.

Version : Cône et collerette durcir (52 ± 2 HRC) et rectifiés. Corps doux pour un usinage ultérieur.

Teknik özelliği : Konik ve Flanş kısmı sertleştirilmiş (52 ± 2 HRC) ve taşlanmıştır. Bara kısmı işlenebilir yumuşaklıktadır.

Kontrolldorne

Test arbors

Mandrins de contrôle

Fener mili kontrol mastarı

JIS B
6339
(MAS 403 BT)

A

HRC
58±2



Bestell-Nr. Order Nr. Reference Sipariş Nr.	BT	Form	D	A	Kg	Euro
305.18.32.200	BT 30	A	32	200	1,41	
405.18.40.300	BT 40	A	40	300	3,38	
505.18.50.300	BT 50	A	50	300	6,33	

FORM A

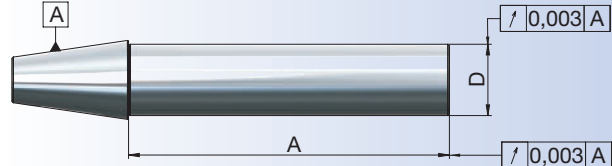

Verwendung : Zur Abnahme von Werkzeugmaschinen gemäß ISO-Empfehlung R230

Application : For acceptance tests of machine tools in accordance with ISO-recommendation R230

Application : Pour la recette technique des machines conforme recommandation ISO R230

Açıklama : Tezgahları devreye alırken ISO Normu R230 sisteminde uygunluğunu kontrol etmek için

JIS B 6339
(MAS 403 BT)



Schrumpffutter zum Spannen von HM Werkzeugschäften

Shrink chuck for mounting of solid carbide cutters

Mandrin de frettage pour le serrage des queue d'outils carbure

İsıtmalı takım tutucular şaftı karbür olan takımlar için

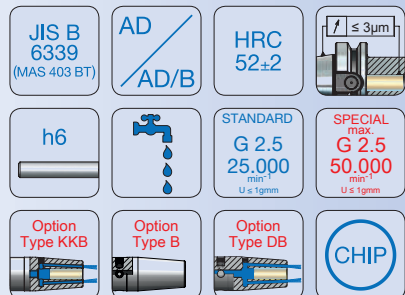

Bestell-Nr. Order Nr. Reference Sipariş Nr.	BT	Form	d	A	D	D1	L2	Kg	Euro
305.25.03.80	BT 30	AD	3	80	10	16	14	0,44	
305.25.04.80	BT 30	AD	4	80	12	20	17	0,47	
305.25.05.80	BT 30	AD	5	80	12	21	20	0,47	
305.25.06.80	BT 30	AD	6	80	21	27	36	0,59	
305.25.08.80	BT 30	AD	8	80	21	27	36	0,58	
305.25.10.80	BT 30	AD	10	80	24	32	42	0,64	
305.25.12.80	BT 30	AD	12	80	24	32	47	0,62	
305.25.14.80	BT 30	AD	14	80	27	34	47	0,67	
305.25.16.80	BT 30	AD	16	80	27	34	50	0,64	
305.25.18.80	BT 30	AD	18	80	33	42	50	0,78	
305.25.20.80	BT 30	AD	20	80	33	42	52	0,74	

FORM AD

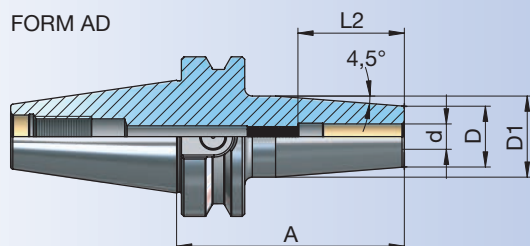

FORM AD/B

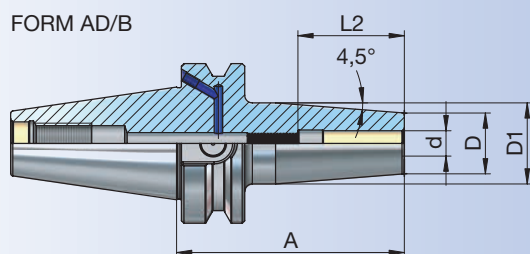

406.25.03.90	BT 40	AD/B	3	90	10	16	14	1,05	
*406.25.03.120	BT 40	AD/B	3	120	10	16	14	1,06	
*406.25.03.160	BT 40	AD/B	3	160	10	16	14	1,11	
new *406.25.03.200	BT 40	AD/B	3	200	10	16	14	1,17	
406.25.04.90	BT 40	AD/B	4	90	12	20	17	1,04	
*406.25.04.120	BT 40	AD/B	4	120	12	20	17	1,12	
*406.25.04.160	BT 40	AD/B	4	160	12	20	17	1,21	
new *406.25.04.200	BT 40	AD/B	4	200	12	20	17	1,30	
406.25.05.90	BT 40	AD/B	5	90	12	21,5	20	1,04	
*406.25.05.120	BT 40	AD/B	5	120	12	22	20	1,13	
*406.25.05.160	BT 40	AD/B	5	160	12	22	20	1,24	
new *406.25.05.200	BT 40	AD/B	5	200	12	22	20	1,34	
406.25.06.90	BT 40	AD/B	6	90	21	27	36	1,19	
406.25.06.120	BT 40	AD/B	6	120	21	27	36	1,31	
406.25.06.160	BT 40	AD/B	6	160	21	27	36	1,48	
new 406.25.06.200	BT 40	AD/B	6	200	21	27	36	1,64	
406.25.08.90	BT 40	AD/B	8	90	21	27	36	1,19	
406.25.08.120	BT 40	AD/B	8	120	21	27	36	1,31	
406.25.08.160	BT 40	AD/B	8	160	21	27	36	1,47	
new 406.25.08.200	BT 40	AD/B	8	200	21	27	36	1,65	



* Einstellschraube nicht enthalten
 * Does not include adjusting screw
 * Ne comprend pas la vis de réglage
 * Dayama civatası içermez

Zubehör / Accessories / Accessoires / Yedekler



Schrumpffutter zum Spannen von HM Werkzeugschäften



Shrink chuck for mounting of solid carbide cutters

Mandrin de frettage pour le serrage des queue d'outils carbure

Isıtmalı takım tutucular şaftı karbür olan takımlar için

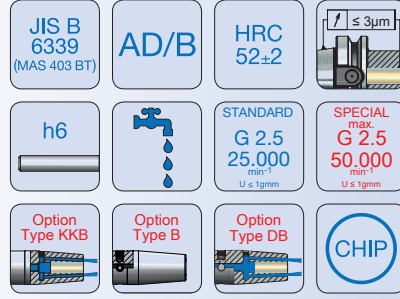

JIS B 6339
(MAS 403 BT)

Bestell-Nr. Order Nr. Reference Sipariş Nr.	BT	Form	d	A	D	D1	L2	Kg	Euro
406.25.10.90	BT 40	AD/B	10	90	24	32	42	1,25	
406.25.10.120	BT 40	AD/B	10	120	24	32	42	1,43	
406.25.10.160	BT 40	AD/B	10	160	24	32	42	1,66	
new 406.25.10.200	BT 40	AD/B	10	200	24	32	42	1,90	
406.25.12.90	BT 40	AD/B	12	90	24	32	47	1,22	
406.25.12.120	BT 40	AD/B	12	120	24	32	47	1,38	
406.25.12.160	BT 40	AD/B	12	160	24	32	47	1,60	
new 406.25.12.200	BT 40	AD/B	12	200	24	32	47	1,82	
406.25.14.90	BT 40	AD/B	14	90	27	34	47	1,27	
406.25.14.120	BT 40	AD/B	14	120	27	34	47	1,45	
406.25.14.160	BT 40	AD/B	14	160	27	34	47	1,71	
new 406.25.14.200	BT 40	AD/B	14	200	27	34	47	1,95	
406.25.16.90	BT 40	AD/B	16	90	27	34	50	1,25	
406.25.16.120	BT 40	AD/B	16	120	27	34	50	1,43	
406.25.16.160	BT 40	AD/B	16	160	27	34	50	1,69	
new 406.25.16.200	BT 40	AD/B	16	200	27	34	50	1,93	
406.25.18.90	BT 40	AD/B	18	90	33	42	50	1,40	
406.25.18.120	BT 40	AD/B	18	120	33	42	50	1,70	
406.25.18.160	BT 40	AD/B	18	160	33	42	50	2,10	
new 406.25.18.200	BT 40	AD/B	18	200	33	42	50	2,50	
406.25.20.90	BT 40	AD/B	20	90	33	42	52	1,37	
406.25.20.120	BT 40	AD/B	20	120	33	42	52	1,67	
406.25.20.160	BT 40	AD/B	20	160	33	42	52	2,07	
new 406.25.20.200	BT 40	AD/B	20	200	33	42	52	2,47	
406.25.25.90	BT 40	AD/B	25	90	44	53	58	1,65	
406.25.25.120	BT 40	AD/B	25	120	44	53	58	2,14	
406.25.25.160	BT 40	AD/B	25	160	44	53	58	2,80	
new 406.25.25.200	BT 40	AD/B	25	200	44	53	58	3,45	
406.25.32.90	BT 40	AD/B	32	90	44	53	62	1,49	
406.25.32.120	BT 40	AD/B	32	120	44	53	62	1,98	
406.25.32.160	BT 40	AD/B	32	160	44	53	62	2,63	
new 406.25.32.200	BT 40	AD/B	32	200	44	53	62	3,28	

FORM AD/B

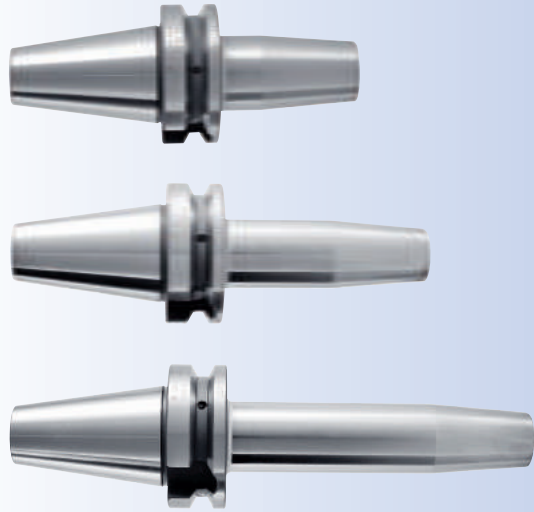
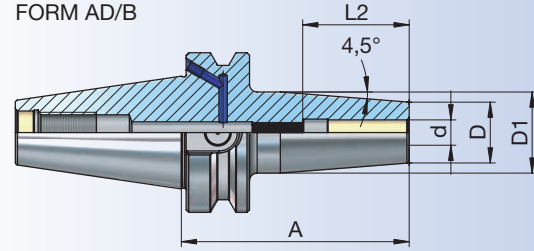

Zubehör / Accessories / Accessoires / Yedekler

DIN 916



Einstellschraube
Adjusting screw
Vis de réglage
Dayama civatası

10.41-10.43



11.08



Schrumpffutter zum Spannen von HM Werkzeugschäften

Shrink chuck for mounting of solid carbide cutters

Mandrin de frettage pour le serrage des queue d'outils carbure

Isıtmalı takım tutucular şaftı karbür olan takımlar için

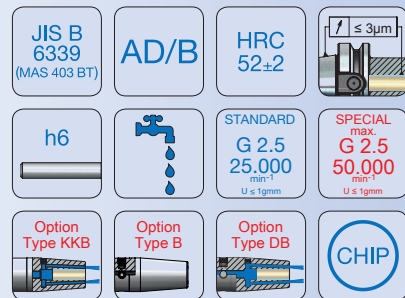

Bestell-Nr. Order Nr. Reference Sipariş Nr.	BT	Form	d	A	D	D1	L2	Kg	Euro
506.25.03.100	BT 50	AD/B	3	100	10	16	14	3,64	
*506.25.03.120	BT 50	AD/B	3	120	10	16	14	3,68	
*506.25.03.160	BT 50	AD/B	3	160	10	16	14	3,73	
new *506.25.03.200	BT 50	AD/B	3	200	10	16	14	3,79	
506.25.04.100	BT 50	AD/B	4	100	12	20	17	3,68	
*506.25.04.120	BT 50	AD/B	4	120	12	20	17	3,73	
*506.25.04.160	BT 50	AD/B	4	160	12	20	17	3,82	
new *506.25.04.200	BT 50	AD/B	4	200	12	20	17	3,91	
506.25.05.100	BT 50	AD/B	5	100	12	21,5	20	3,68	
*506.25.05.120	BT 50	AD/B	5	120	12	22	20	3,73	
*506.25.05.160	BT 50	AD/B	5	160	12	22	20	3,84	
new *506.25.05.200	BT 50	AD/B	5	200	12	22	20	3,95	
506.25.06.100	BT 50	AD/B	6	100	21	27	36	3,84	
506.25.06.120	BT 50	AD/B	6	120	21	27	36	3,92	
506.25.06.160	BT 50	AD/B	6	160	21	27	36	4,08	
new 506.25.06.200	BT 50	AD/B	6	200	21	27	36	4,24	
506.25.08.100	BT 50	AD/B	8	100	21	27	36	3,83	
506.25.08.120	BT 50	AD/B	8	120	21	27	36	3,91	
506.25.08.160	BT 50	AD/B	8	160	21	27	36	4,07	
new 506.25.08.200	BT 50	AD/B	8	200	21	27	36	4,23	
506.25.10.100	BT 50	AD/B	10	100	24	32	42	3,86	
506.25.10.120	BT 50	AD/B	10	120	24	32	42	4,01	
506.25.10.160	BT 50	AD/B	10	160	24	32	42	4,25	
new 506.25.10.200	BT 50	AD/B	10	200	24	32	42	4,50	
506.25.12.100	BT 50	AD/B	12	100	24	32	47	3,85	
506.25.12.120	BT 50	AD/B	12	120	24	32	47	3,96	
506.25.12.160	BT 50	AD/B	12	160	24	32	47	4,18	
new 506.25.12.200	BT 50	AD/B	12	200	24	32	47	4,39	

FORM AD/B

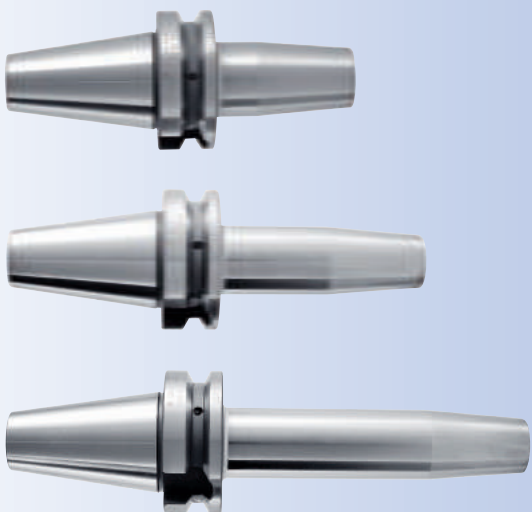
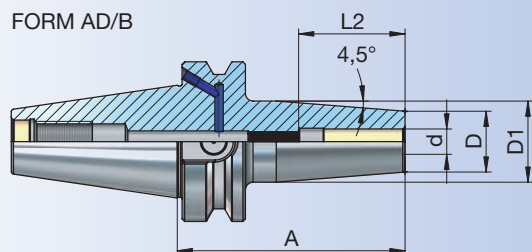

- * Einstellschraube nicht enthalten
- * Does not include adjusting screw
- * Ne comprend pas la vis de réglage
- * Dayama civatası içermez

Zubehör / Accessories / Accessoires / Yedekler

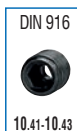

Einstellschraube
Adjusting screw
Vis de réglage
Dayama civatası



11.08

Schrumpffutter zum Spannen von HM Werkzeugschäften

Shrink chuck for mounting of solid carbide cutters

Mandrin de frettage pour le serrage des queue d'outils carbure

Isıtmalı takım tutucular şaftı karbür olan takımlar için

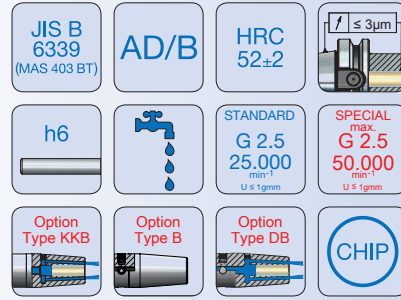

JIS B 6339
(MAS 403 BT)

Bestell-Nr. Order Nr. Reference Sipariş Nr.	BT	Form	d	A	D	D1	L2	Kg	Euro
506.25.14.100	BT 50	AD/B	14	100	27	34	47	3,90	
506.25.14.120	BT 50	AD/B	14	120	27	34	47	4,02	
506.25.14.160	BT 50	AD/B	14	160	27	34	47	4,27	
new 506.25.14.200	BT 50	AD/B	14	200	27	34	47	4,52	
506.25.16.100	BT 50	AD/B	16	100	27	34	50	3,88	
506.25.16.120	BT 50	AD/B	16	120	27	34	50	4,00	
506.25.16.160	BT 50	AD/B	16	160	27	34	50	4,25	
new 506.25.16.200	BT 50	AD/B	16	200	27	34	50	4,50	
506.25.18.100	BT 50	AD/B	18	100	33	42	50	4,03	
506.25.18.120	BT 50	AD/B	18	120	33	42	50	4,22	
506.25.18.160	BT 50	AD/B	18	160	33	42	50	4,63	
new 506.25.18.200	BT 50	AD/B	18	200	33	42	50	5,04	
506.25.20.100	BT 50	AD/B	20	100	33	42	52	4,00	
506.25.20.120	BT 50	AD/B	20	120	33	42	52	4,20	
506.25.20.160	BT 50	AD/B	20	160	33	42	52	4,60	
new 506.25.20.200	BT 50	AD/B	20	200	33	42	52	5,03	
506.25.25.110	BT 50	AD/B	25	110	44	53	58	4,44	
506.25.25.120	BT 50	AD/B	25	120	44	53	58	4,60	
506.25.25.160	BT 50	AD/B	25	160	44	53	58	5,25	
new 506.25.25.200	BT 50	AD/B	25	200	44	53	58	5,91	
506.25.32.110	BT 50	AD/B	32	110	44	53	62	4,27	
506.25.32.120	BT 50	AD/B	32	120	44	53	62	4,43	
506.25.32.160	BT 50	AD/B	32	160	44	53	62	5,09	
new 506.25.32.200	BT 50	AD/B	32	200	44	53	62	5,75	

FORM AD/B

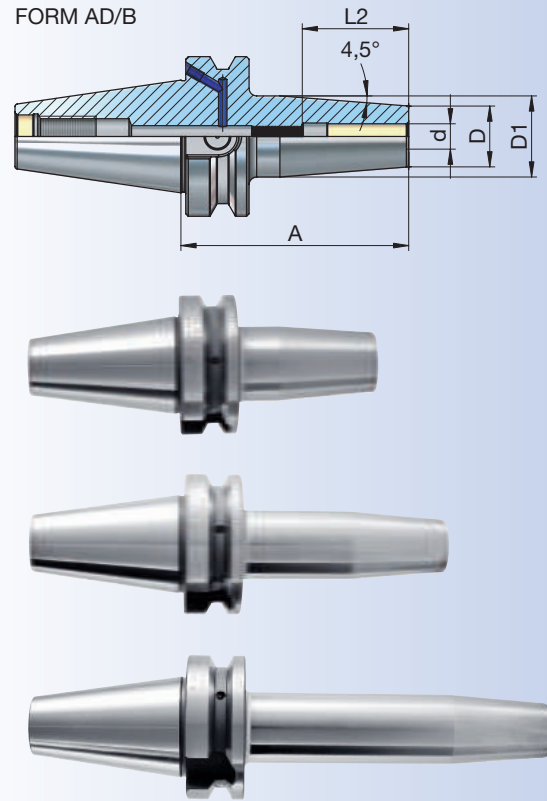

Zubehör / Accessories / Accessoires / Yedekler





Schrumpffutter - schlanke Ausführung für HM Werkzeugschäften

Shrink chucks - slimline design for solid carbide cutters

Mandrins de frettage - design mince four queue d'outils carbure

İnce cidarlı ısıtmalı takım tutucular şaftı karbür olan takımlar için

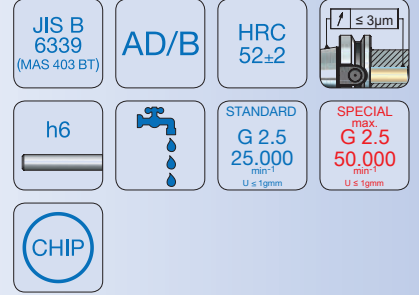

Bestell-Nr. Order Nr. Reference Sipariş Nr.	BT	Form	d	A	D	D1	L2	Kg	Euro
406.25.03.90.S	BT 40	AD/B	3	90	9	15	14	1,00	
*406.25.03.120.S	BT 40	AD/B	3	120	9	18	14	1,04	
406.25.04.90.S	BT 40	AD/B	4	90	10	16	17	1,00	
*406.25.04.120.S	BT 40	AD/B	4	120	10	19	17	1,06	
406.25.05.90.S	BT 40	AD/B	5	90	11	17	20	1,01	
*406.25.05.120.S	BT 40	AD/B	5	120	11	20	20	1,07	
406.25.06.90.S	BT 40	AD/B	6	90	12	18	36	1,04	
406.25.06.120.S	BT 40	AD/B	6	120	12	21	36	1,10	
406.25.06.160.S	BT 40	AD/B	6	160	12	25	36	1,22	
406.25.08.90.S	BT 40	AD/B	8	90	14	20	36	1,06	
406.25.08.120.S	BT 40	AD/B	8	120	14	23	36	1,14	
406.25.08.160.S	BT 40	AD/B	8	160	14	27	36	1,28	
406.25.10.90.S	BT 40	AD/B	10	90	16	22	42	1,08	
406.25.10.120.S	BT 40	AD/B	10	120	16	25	42	1,17	
406.25.10.160.S	BT 40	AD/B	10	160	16	29	42	1,34	
406.25.12.90.S	BT 40	AD/B	12	90	18	24	47	1,08	
406.25.12.120.S	BT 40	AD/B	12	120	18	27	47	1,17	
406.25.12.160.S	BT 40	AD/B	12	160	18	31	47	1,36	

506.25.03.100.S	BT 50	AD/B	3	100	9	15	14	3,63	
*506.25.03.120.S	BT 50	AD/B	3	120	9	17,5	14	3,66	
506.25.04.100.S	BT 50	AD/B	4	100	10	16	17	3,64	
*506.25.04.120.S	BT 50	AD/B	4	120	10	18,5	17	3,67	
506.25.05.100.S	BT 50	AD/B	5	100	11	17	20	3,65	
*506.25.05.120.S	BT 50	AD/B	5	120	11	19,5	20	3,68	
506.25.06.100.S	BT 50	AD/B	6	100	12	18	36	3,69	
506.25.06.120.S	BT 50	AD/B	6	120	12	20,5	36	3,72	
506.25.06.160.S	BT 50	AD/B	6	160	12	24,5	36	3,83	
506.25.08.100.S	BT 50	AD/B	8	100	14	20	36	3,70	
506.25.08.120.S	BT 50	AD/B	8	120	14	22,5	36	3,75	
506.25.08.160.S	BT 50	AD/B	8	160	14	26,5	36	3,88	
506.25.10.100.S	BT 50	AD/B	10	100	16	22	42	3,72	
506.25.10.120.S	BT 50	AD/B	10	120	16	24,5	42	3,78	
506.25.10.160.S	BT 50	AD/B	10	160	16	28,5	42	3,94	
506.25.12.100.S	BT 50	AD/B	12	100	18	24	47	3,71	
506.25.12.120.S	BT 50	AD/B	12	120	18	26,5	47	3,77	
506.25.12.160.S	BT 50	AD/B	12	160	18	30,5	47	3,94	

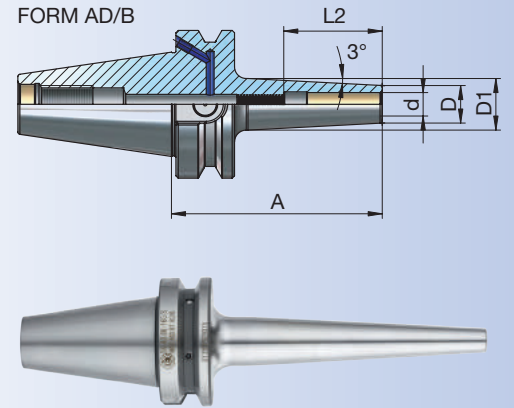

- * Einstellschraube nicht enthalten
- * Does not include adjusting screw
- * Ne comprend pas la vis de réglage
- * Dayama civatası içermez

Zubehör / Accessories / Accessoires / Yedekler



Hydro - Dehnspannfutter

Hydraulic expansions chuck

Mandrins expansibles hydrauliques

Hidrolik takım tutucular

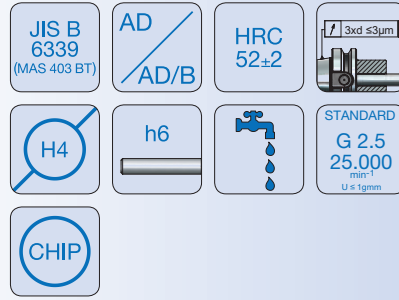

JIS B 6339
(MAS 403 BT)

Bestell-Nr. Order Nr. Reference Sipariş Nr.	BT	Form	d	A	D	D1	L1	L2	Kg	Euro
305.65.12.85	BT 30	AD	12	85	26,5	49,5	46	46	0,80	
305.65.20.90	BT 30	AD	20	90	36	49,5	40	51	0,93	
406.65.06.90	BT 40	AD/B	6	90	26	49,5	40	37	1,41	
406.65.08.90	BT 40	AD/B	8	90	28	49,5	40	37	1,40	
406.65.10.90	BT 40	AD/B	10	90	30	49,5	40	41	1,38	
406.65.12.90	BT 40	AD/B	12	90	32	49,5	40	46	1,39	
406.65.14.90	BT 40	AD/B	14	90	34	49,5	40	46	1,41	
406.65.16.90	BT 40	AD/B	16	90	38	49,5	46	49	1,43	
406.65.18.90	BT 40	AD/B	18	90	38	49,5	46	49	1,45	
406.65.20.90	BT 40	AD/B	20	90	42	49,5	46	51	1,47	
406.65.25.90	BT 40	AD/B	25	90	49,5	55	63	57	1,77	
406.65.32.90	BT 40	AD/B	32	90	56	63	63	61	1,90	
506.65.06.110	BT 50	AD/B	6	110	26	49,5	40	37	4,16	
506.65.08.110	BT 50	AD/B	8	110	28	49,5	40	37	4,21	
506.65.10.110	BT 50	AD/B	10	110	30	49,5	40	41	4,10	
506.65.12.110	BT 50	AD/B	12	110	32	49,5	40	46	4,19	
506.65.14.110	BT 50	AD/B	14	110	34	49,5	40	46	4,14	
506.65.16.110	BT 50	AD/B	16	110	38	49,5	46	49	4,15	
506.65.18.110	BT 50	AD/B	18	110	40	49,5	46	49	4,28	
506.65.20.110	BT 50	AD/B	20	110	42	49,5	46	51	4,19	
506.65.25.110	BT 50	AD/B	25	110	55	60	55	57	4,51	
506.65.32.115	BT 50	AD/B	32	115	63	70	55	61	4,86	

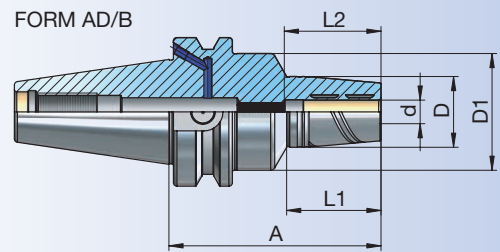
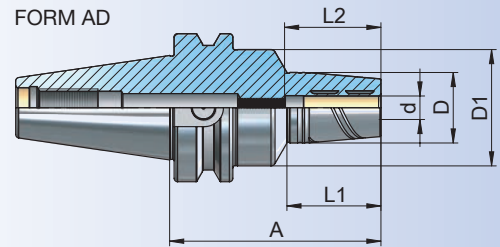

Zubehör / Accessories / Accessoires / Yedekler



Reduzierungen
Reducing arbor
Douille de réduction
Pens

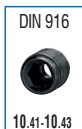

DIN 916
Einstellschraube
Adjusting screw
Vis de réglage
Dayama civatası



Spannschlüssel
Wrench
Clé de serrage
Sıkma anahtarı



Büchsenzieher für Reduzierungen
Sleeve remover for reducing arbor
Clé étirage pour douilles
Hidrolik Takım Pensi Çıkarma Anahtarı



11.10



Hydro - Dehnspannfutter lange Ausführung

Hydraulic expansions chuck, long

Mandrins expansibles hydrauliques, longue

Hidrolik takım tutucular, uzun

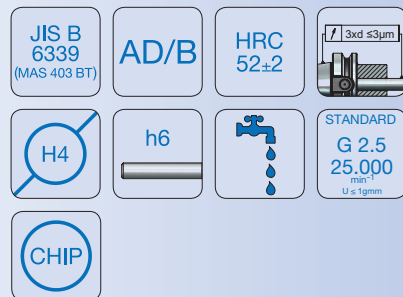

Bestell-Nr. Order Nr. Reference Sipariş Nr.	BT	Form	d	A	D	D1	L1	L2	Kg	Euro
406.65.06.140	BT 40	AD/B	6	140	26	49,5	40	37	2,18	
406.65.08.140	BT 40	AD/B	8	140	28	49,5	40	37	2,11	
406.65.10.140	BT 40	AD/B	10	140	30	49,5	40	41	2,10	
406.65.12.140	BT 40	AD/B	12	140	32	49,5	40	46	2,22	
406.65.14.140	BT 40	AD/B	14	140	34	49,5	40	46	2,22	
406.65.16.140	BT 40	AD/B	16	140	38	49,5	46	49	2,09	
406.65.18.140	BT 40	AD/B	18	140	40	49,5	46	49	2,14	
406.65.20.140	BT 40	AD/B	20	140	42	49,5	46	51	2,18	
406.65.25.140	BT 40	AD/B	25	140	49,5	55	113	57	2,67	
406.65.32.140	BT 40	AD/B	32	140	56	63	113	61	3,03	

506.65.06.140	BT 50	AD/B	6	140	26	49,5	40	37	4,87	
506.65.08.140	BT 50	AD/B	8	140	28	49,5	40	37	4,89	
506.65.10.140	BT 50	AD/B	10	140	30	49,5	40	41	4,91	
506.65.12.140	BT 50	AD/B	12	140	32	49,5	40	46	4,90	
506.65.14.140	BT 50	AD/B	14	140	34	49,5	40	46	4,57	
506.65.16.140	BT 50	AD/B	16	140	38	49,5	46	49	4,81	
506.65.18.140	BT 50	AD/B	18	140	40	49,5	46	49	4,80	
506.65.20.140	BT 50	AD/B	20	140	42	49,5	46	51	3,47	
506.65.25.140	BT 50	AD/B	25	140	55	60	55	57	5,34	
506.65.32.140	BT 50	AD/B	32	140	63	70	55	61	5,09	

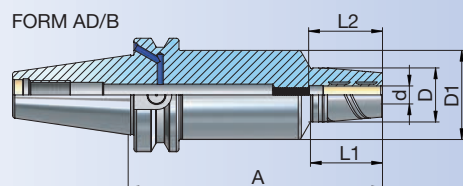

Hydro - Dehnspannfutter schlanke Ausführung

Hydraulic expansions chuck, slimline design

Mandrins expansibles hydrauliques, design mince

Hidrolik takım tutucular, ince cidarlı

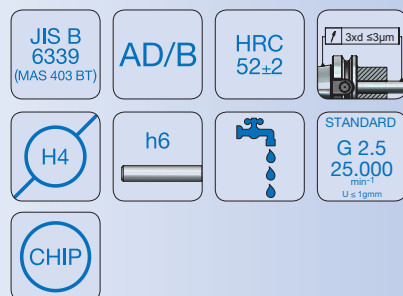

Bestell-Nr. Order Nr. Reference Sipariş Nr.	BT	Form	d	A	D	D1	L1	L2	Kg	Euro
406.65.12.120.S	BT 40	AD/B	12	120	25	49,5	60	46	1,55	
506.65.12.120.S	BT 50	AD/B	12	120	25	49,5	60	46	4,10	

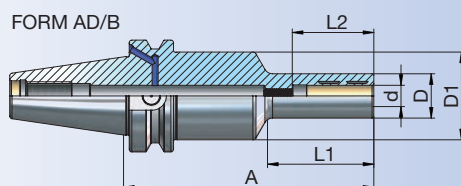

Zubehör / Accessories / Accessoires / Yedekler



Reduzierungen
Reducing arbor
Douille de réduction
Pens

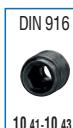

Einstellschraube
Adjusting screw
Vis de réglage
Dayama civatası



Spannschlüssel
Wrench
Clé de serrage
Sıkma anahtarı



Büchsenzieher für Reduzierungen
Sleeve remover for reducing arbor
Clé étréage pour douilles
Hidrolik Takım Pensi Çıkarma Anahtarı





JIS B 6339
(MAS 403 BT)

Hydro - Dehnspannfutter extra kurze Ausführung

Hydraulic expansions chuck extra, short

Mandrins expansibles hydrauliques extra, court

Hidrolik takım tutucu, ekstra kısa

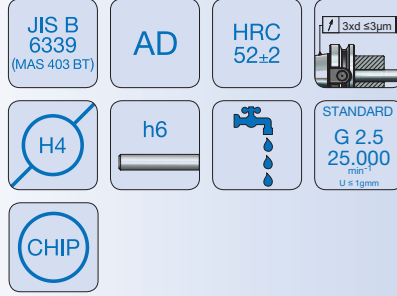

Bestell-Nr. Order Nr. Reference Sipariş Nr.	BT	Form	d	A	D	L2	Kg	Euro
405.65.20.32	BT 40	AD	20	32,5	49,5	51	0,89	

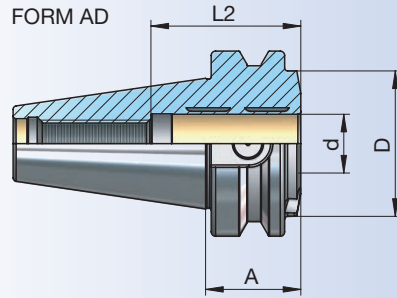

Zubehör / Accessories / Accessoires / Yedekler



Reduzierungen
Reducing arbor
Douille de réduction
Pens



Spannschlüssel
Wrench
Clé de serrage
Sıkma anahtarı



Büchsenzieher für Reduzierungen
Sleeve remover for reducing arbor
Clé étréage pour douilles
Hidrolik Takım Pensi Çıkarma Anahtarı

Hydro - Dehnspannfutter kurz /schwer

Hydraulic expansions chuck, short heavy

Mandrins expansibles hydrauliques, court lourd

Hidrolik takım tutucu, kısa rijit

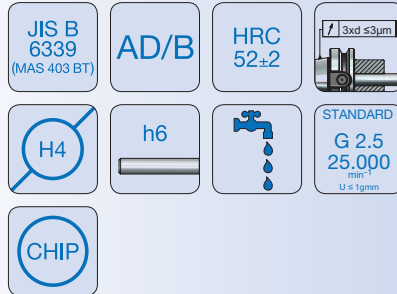

Bestell-Nr. Order Nr. Reference Sipariş Nr.	BT	Form	d	A	D	L2	Kg	Euro
406.65.20.72	BT 40	AD/B	20	72,5	49,5	51	1,42	

506.65.20.83	BT 50	AD/B	20	83	49,5	51	3,94	
506.65.32.90	BT 50	AD/B	32	90	72	61	4,59	

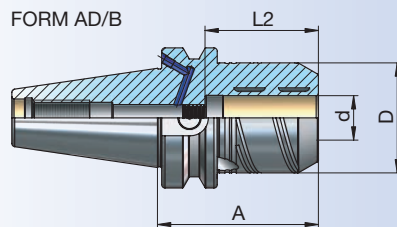

Zubehör / Accessories / Accessoires / Yedekler



Reduzierungen
Reducing arbor
Douille de réduction
Pens

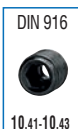

DIN 916
Einstellschraube
Adjusting screw
Vis de réglage
Dayama civatası



Spannschlüssel
Wrench
Clé de serrage
Sıkma anahtarı



Büchsenzieher für Reduzierungen
Sleeve remover for reducing arbor
Clé étréage pour douilles
Hidrolik Takım Pensi Çıkarma Anahtarı



11.10



Hydro-Dehnspannfuttersatz im Koffer

Hydraulic expansion chuck set in box

Mandrin expansibles hydraulique (set) dans coffre

Hidrolik tutucu seti plastik kutuda

JIS B
6339
(MAS 403 BT)

AD
AD/B

HRC
52±2



Bestell-Nr. Order Nr. Reference Sipariş Nr.	BT	Form	Spannbereich Capacity Capacité Kapasite	Spannzangen Durchmesser Collet Diameter Pincas Diamètre Pens Çapı	Reduzierhulsen Reducing Réduction Pens Adedi	Kg	Euro
305.66.12.85	BT 30	AD	R12 (3-8)	3-4-5-6-8	5	1,65	
305.66.20.90	BT 30	AD	R20 (6-16)	6-8-10-12-16	5	1,96	
406.66.12.90	BT 40	AD/B	R12 (3-8)	3-4-5-6-8	5	2,24	
406.66.20.72	BT 40	AD/B	R20 (6-16)	6-8-10-12-16	5	2,43	
406.66.20.90	BT 40	AD/B	R20 (6-16)	6-8-10-12-16	5	2,48	
406.66.32.90	BT 40	AD/B	R32 (6-25)	6-8-10-12-16-20-25	7	4,34	
506.66.12.110	BT 50	AD/B	R12 (3-8)	3-4-5-6-8	5	5,45	
506.66.20.83	BT 50	AD/B	R20 (6-16)	6-8-10-12-16	5	5,34	
506.66.20.110	BT 50	AD/B	R20 (6-16)	6-8-10-12-16	5	5,59	
506.66.32.90	BT 50	AD/B	R32 (6-25)	6-8-10-12-16-20-25	7	7,23	
506.66.32.115	BT 50	AD/B	R32 (6-25)	6-8-10-12-16-20-25	7	7,50	

Lieferumfang : Spannfüter, inkl. Spannzangen mit Schlüssel
Included : Collet chuck with collets and wrench
Inclus : Mandarin avec pincas et clé
Teslim Şekli : Takım, pensleri ve anahtarıyla birlikte



Zubehör / Accessories / Accessoires / Yedekler



10.20-10.21
Reduzierungen
Reducing arbor
Douille de réduction
Pens



10.41-10.43
Einstellschraube
Adjusting screw
Vis de réglage
Dayama civatası



10.49
Spannschlüssel
Wrench
Clé de serrage
Sıkma anahtarı



10.48
Büchsenzieher für Reduzierungen
Sleeve remover for reducing arbor
Clé étréage pour douilles
Hidrolik Takım Pensi Çıkarma Anahtarı



11.10